



MGS-408

Gas Detection Controller *for Commercial & Industrial Applications*



Fixed Gas Detection

P/N: 1100-2295 | February 2020 Revision 1

User Manual

3.3. Suitable / Appropriate Locations

The MGS-408 Gas Detection Controller should be centrally located in the facility (*preferably outside of the mechanical room*) and should be easily accessible for visual monitoring and servicing. This is the “split architecture design” for safety of the operator.

Dirt, grease, and oils can adversely affect the operation of the controller. The controller should be installed out of direct sunlight in a clean, dry area that is not subject to temperature or humidity extremes. Installation in a mechanical room is acceptable provided reasonable environmental conditions exist. If there is a question, consider installing the unit outside of the mechanical room in a cleaner area of the facility.

The controller can be located up to 1,000 feet (305 m) from the furthest gas monitor when using RS485 communications. The available distance is less when using the controller as the power supply for down line gas transmitters. Careful attention to voltage drop over distance with a suitable wire gauge employed is also required. (*See “3.6.1 MGS-408 Gas Detection Controller Network” on page 12.*)

The controller provides an interface by which you can monitor, acknowledge alarms, and observe conditions inside the mechanical room.

3.4. Mounting the Gas Detection Controller

The MGS-408 Gas Detection Controller should be installed plumb, level and securely fastened to a rigid mounting surface. The enclosure utilizes four mounting holes designed for #6 (or M3.5 or M4) pan head fasteners (*included*). Mounting holes are located in the four corners of the enclosure, accessed by loosening the two screws on the top of the enclosure lid and opening the front panel. Install and adjust the screws as necessary to hold the unit securely against the mounting surface, close the front panel and tighten the screws.



WARNING: Copper conductors for connection to supply mains must be made in accordance with NEC / CEC and local codes.



NOTE: A certified AC power disconnect or circuit breaker should be mounted near the controller and installed following applicable local and national codes. If a switch is used instead of a circuit breaker, a properly rated CERTIFIED fuse or current limiter is required to be installed as per local or national codes. Markings for positions of the switch or breaker should state (I) for on and (O) for off.

3.5. Electrical Wiring

The controller enclosure features two M20 cable glands that are intended for power entry. If conduit is preferred, simply remove one of the M20 glands and install a suitable ½" conduit adapter.

Locate the AC power and Ground on the power input terminal block. Secure the incoming AC power neutral (*white / blue*), live (*black / brown*) and ground wires to the appropriate terminals, using a screwdriver on the press-to-release tabs.

Figure 4-2 - MGS-408 Wiring Diagram

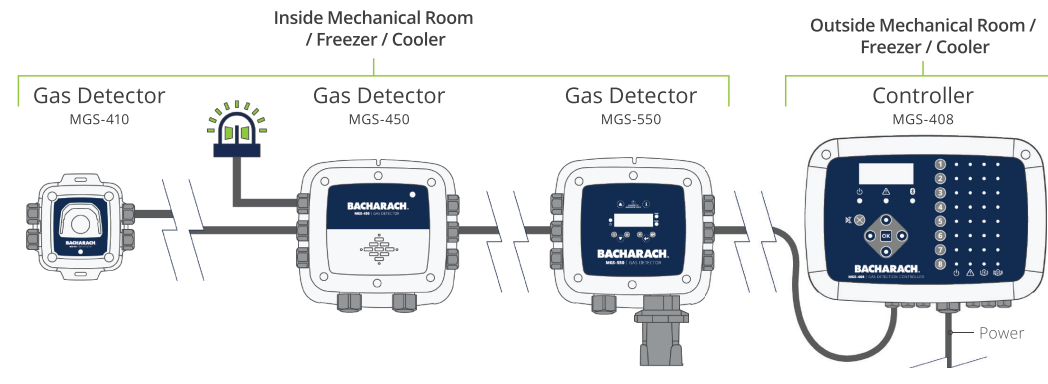
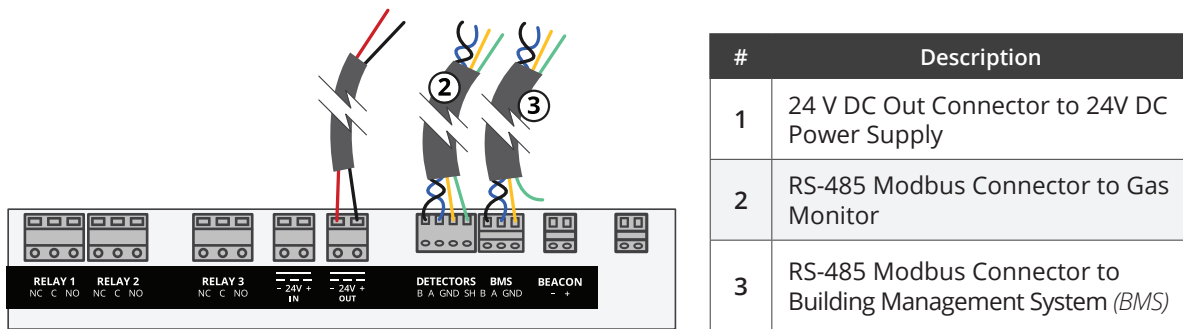

3.6. Communications Connections

3.6.1 MGS-408 Gas Detection Controller Network

The MGS-408 Gas Detection Controller is connected to MGS-410, 450, 460, 550, 250 gas detectors using a shielded twisted pair instrument cable (*Belden 3106A or equivalent*).

The maximum distance between the MGS-408 and the furthest Bacharach gas sensor when using Modbus communications is 1,000ft (305m). This distance is reduced when using the MGS-408 as the power source for the Bacharach gas sensors due to voltage drops in the cable. When using the MGS-408 as a power source for the Bacharach sensors the following needs to be taken into consideration; the total power requirements of the sensors, the wire gauge of the cable being used and the distance to the furthest gas detector.

i **NOTE:** Recommended cable for Modbus and sensor power is 16-20AWG, Belden 3106A shielded / twisted pair.

Power Requirements for Bacharach gas sensors

Model	Load (W)
MGS-250	2.5
MGS-410	4
MGS-450	4
MGS-460	4
MGS-550	8

i **NOTE:** When using an MGS-550 Gas Detector with two sensors connected it will count as (2) channels on the controller.

The maximum distance to the furthest sensor should not exceed the following lengths based on the total power requirements of all of the sensors to be connected to the MGS-408; i.e., (8) MGS-410 sensors is a total power of 32w.

Total Load (W)	Maximum Wire Length in ft (m)				
	20 AWG	18 AWG	16 AWG	14 AWG	12 AWG
2	1,000 (305)	1,000 (305)	1,000 (305)	1,000 (305)	1,000 (305)
4	1,000 (305)	1,000 (305)	1,000 (305)	1,000 (305)	1,000 (305)
6	724 (221)	1,000 (305)	1,000 (305)	1,000 (305)	1,000 (305)
8	543 (166)	861 (263)	1,000 (305)	1,000 (305)	1,000 (305)
10	434 (133)	689 (210)	1,000 (305)	1,000 (305)	1,000 (305)
12	362 (111)	574 (175)	914 (279)	1,000 (305)	1,000 (305)

14	310 (95)	492 (150)	783 (239)	1,000 (305)	1,000 (305)
16	271 (83)	430 (132)	685 (209)	1,000 (305)	1,000 (305)
18	241 (74)	383 (117)	609 (186)	967 (295)	1,000 (305)
20	217 (67)	344 (105)	548 (168)	870 (266)	1,000 (305)
22	197 (61)	313 (96)	498 (152)	791 (242)	1,000 (305)
24	181 (56)	287 (88)	457 (140)	725 (221)	1,000 (305)
26	167 (51)	265 (81)	422 (129)	670 (205)	1,000 (305)
28	155 (48)	246 (75)	392 (120)	622 (190)	989 (302)
30	145 (45)	230 (71)	365 (112)	580 (177)	923 (282)
32	136 (42)	215 (66)	343 (105)	544 (166)	866 (264)

The RS-485 communication wiring between the gas monitor and MGS-408 Gas Detection Controller must be connected in the following manner:

1. Locate the Modbus/RS-485 connector in the gas detector. (Refer to "Figure 4-3 - MGS-408 Wiring Diagram" on page 16. For additional information, see appropriate gas monitor manual.)
2. Connect one lead of a twisted shielded pair to the "B" connection point; note the wire color.
3. Connect the second wire to the "A" connection point; note the wire color.
4. Connect the ground to the "GND" connection point.
5. Connect the shield or drain wire to the "SH" connection point.
6. Locate the Modbus/RS-485 connectors in the MGS-408 Gas Detection Controller. The left Modbus/RS-485 connector (labeled "Detectors") is for down line "slave" devices (includes a dedicated shield position) and the right Modbus/RS-485 connector (labeled "BMS") is used to connect to "master" devices up line, such as building management controls.

3.6.2 Integration with Building Management System

A second RS-485 connector allows a Building Management System to communicate with the MGS-408 Gas Detection Controller via Modbus protocol (see "5.2. MODBUS Registers" on page 29). The connection is established using a shielded twisted pair instrument cable (Belden 3106A or equivalent). Use any of the remaining service cable glands to gain access to the interior of the MGS-408 Gas Detection Controller. Locate the Modbus/RS-485 connector. Secure the wire leads to the connector in the orientation as displayed on the board. Check to make sure the polarity matches the wiring to the Building Management System. The shield connection should only be grounded at the BMS device and should not be connected at the controller.

3.7. Connecting External Alarms

3.7.1 Overview

One switched 24 VDC contact marked “BEACON” is available for the connection of an external beacon. The terminals can sink up to 300 mA at 24 VDC.

Form C relay contacts are provided for FAULT, LO ALARM and HI ALARM conditions.

3.7.2 Connection Guidelines



CAUTION: Use the remaining cable glands to gain access to the interior of the controller. Drilling holes in the MGS-408 Gas Detection Controller enclosure may damage the unit and will void the warranty. Locate the relay connectors. Secure the wire leads to the connectors.



NOTE: Power for the external alarms can be tapped off the AC IN connector.



NOTE: The relay contacts are rated 5A at 250VAC (N.O. contact) and 2A at 250VAC (N.C. contact). (Refer to “Figure 4-1 - MGS-408 Wiring Diagram” on page 16.)

4. Operation

4.1. Overview

4.1.1 Main Function

Every five seconds the MGS-408 Gas Detection Controller collects gas concentration and status information from each connected gas detector. Gas concentration appears on the LCD display and connection status, fault and alarm conditions are indicated by the LED matrix for each channel. When an SD card is installed and data logging is enabled (see Section 4.4 on page 25), concentration and status information is logged every 10-seconds for all connected gas detectors. Detector data and controller status information can also be communicated via MODBUS, to a master or BMS device.

4.1.2 Power Up

After power up, the firmware revision level will be indicated on the LCD followed by an LED/LCD and beacon self test. The controller will then begin scanning connected detectors and display their reported gas concentration on the LCD and status information on the LED matrix.

4.1.3 Channel Number Keys

Pressing a Channel number key will bring up a scrollable channel detail screen with detector specific information. Pressing the channel number key a second time will access the channel setup menu.

4.1.4 Menu Access and Navigation

To access the System level menu:

- ▶ *Main Menu* → press *OK*. The currently selected menu item is indicated with triangle pointers to the left and right of the description.

If the menu list is longer than can be displayed, up and down arrow keys on the right side of the screen will indicate additional items are available by either scrolling up or down.

Figure 4-3 - Main Menu

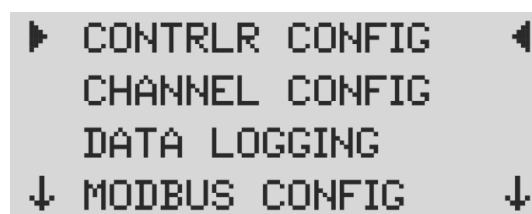

Some of the screens you will access will require data entry, such as the date/time setup or location description. These screens will appear with a character selected, as displayed below. Use the up / down Arrow keys to scroll through the characters provided for that character's place. Use the left / right Arrow keys to move the cursor to the next character. When all character selections for the screen are completed, press OK to accept the entries.

Figure 4-4 - Example of Data Entry Required

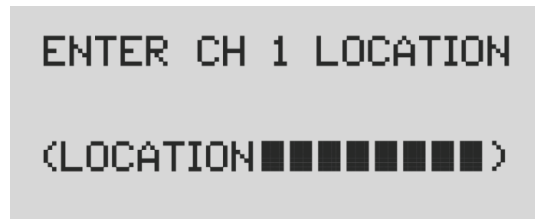

4.2. Controller Setup

Figure 4-5 - MGS-408 Wiring Diagram

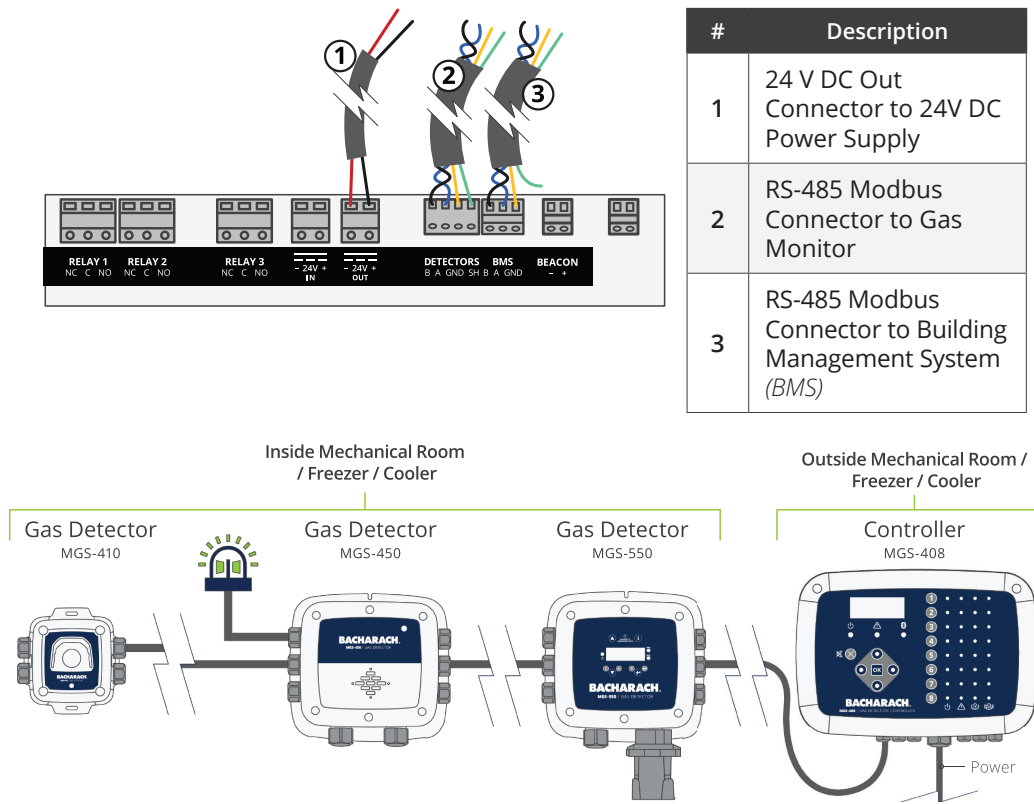

4.2.1 Setup Parameters

Before using the controller, various parameters must be set by the user based on how the controller has been wired.

- ▶ *Main Menu* → *CONTRLR CONFIG* → press *OK*, to access the setup parameters menu.

Figure 4-6 - Setup Controller Configuration

```

▶ CONTRLR CONFIG ◀
  CHANNEL CONFIG
  DATA LOGGING
↓ MODBUS CONFIG ↓
  
```

4.2.2 Relay Setup

To access the Relay setup menu:

- ▶ *Main Menu* → *CONTRLR CONFIG* → *RELAYS* → press *OK*.

From this menu, each of the three relays can be configured for either normal or failsafe operation. The default is normal, meaning normally open contacts will close with the event corresponding the relay designation. If fail safe is selected, the relay will be normally energized and will be de-energized with the relays designated event or a power failure.

To select the type of alarm for each relay:

- ▶ *Main Menu* → *CONTRLR CONFIG* → *RELAYS* → press *OK* to access the Relay setup menu.
- ▶ Press the *Up/Down arrows* to select relay, and press *OK*.
(The configuration type for the selected relay will begin to flash.)
- ▶ Press the *Right/Left arrow* to change the configuration type, press *OK*.

Figure 4-7 - Relay Setup Menu

```

▶ LO ALARM NORM ◀
  HI ALARM NORM
  FAULT      NORM
  
```

Figure 4-8 - Toggling the Alarm Setting

```

▶ LO ALARM FAIL SF ◀
  HI ALARM  NORM
  FAULT     NORM
  
```

4.2.3 Audible / Visual (AV) Alarm Beacon

The beacon, if installed, and the internal buzzer may be enabled to indicate an alarm condition. When enabled, the beacon will be energized, and the buzzer will beep, if either a low or high alarm condition exists.

- ▶ **Main Menu** → **CONTRLR CONFIG** → **AV ALARM** → press **OK**, to access the AV alarm setup menu.
- ▶ Press the **Up/Down arrows** to select relay, and then press **OK**.
(The configuration type for the selected relay will begin to flash.)

Figure 4-9 - AV Alarm Setup

```

BUZZER AND A/V ALARM
ARE - ▶ENABLED ◀
  
```

4.2.4 Fault Latching

Fault latching defaults to DISABLED, allowing the fault indication to clear the condition without user intervention. When ENABLED the fault indication will persist after the condition has cleared, until a user clears the current faults by selecting "CLEAR FAULT" from the diagnostic menu.

Figure 4-10 - Fault Latching

```

FAULT LATCHING
IS - ▶DISABLED ◀
  
```

4.2.5 LCD Contrast

From the LCD contrast setting screen, the contrast can be adjusted from 1-63, with 30 being the default.

- ▶ *Main Menu* → *CONTRLR CONFIG* → *LCD CONTRAST* → press *OK*, to access the contrast menu.
- ▶ Press the *Right/Left arrows* to adjust the contrast, press *OK*.

Figure 4-11 - Contrast Setting



USE ARROW KEYS
TO ADJUST CONTRAST
30

4.2.6 LED Brightness & Auto-dimming

The brightness of front panel LEDs can be adjusted from 0-10.

- ▶ *Main Menu* → *CONTRLR CONFIG* → *LCD BRIGHTNESS* → press *OK*, to access the brightness menu.
- ▶ Press the *Right/Left arrows* to adjust the brightness, press *OK*.

A full bright setting of 10 will be visible from a long distance but may be too bright when the user is operating the keypad. For this reason, when the keypad is in use the LED brightness will auto-dim to a comfortable level, and resume the programmed brightness setting after a period of keypad inactivity.

Figure 4-12 - Brightness Setting



USE ARROW KEYS
TO ADJUST BRIGHTNESS
05

4.2.7 Date / Time

The real time clock should be checked and set after installation or when the coin cell battery is changed. Enter or edit the month, day, year, hour and minute by scrolling the menu.

- ▶ **Main Menu** → **CONTRLR CONFIG** → **DATE/TIME** → press **OK**, to access the date/time menu.
- ▶ Press the **Up or Down arrows** to select date/time increment to change, and then press **OK**.
(The selected numeral will begin to flash.)
- ▶ Press the **Up/Down arrows** to change entry, **Left/Right arrows** to move cursor, press **OK**.

Figure 4-13 - Date/time Menu

▶ MONTH	01	◀
DAY	04	
YEAR	2019	
↓ HOUR	10	↓

4.2.8 Password Protection

The MGS-408 Gas Detection Controller can be password protected to prevent the unauthorized editing of setup parameters. When password protection is enabled, an operator may still navigate between screens to observe settings or monitor network status. The unit is shipped with password protection OFF. Entering a 3 digit (*non-zero*) password enables password protection. After protection is enabled, the user will be prompted to enter the password when an attempt is made to edit a setup parameter. After entering the password, a 30 minute time period will be allowed for entries, after which the user will again be prompted to re-enter the password. To disable password protection, simply change the password to all zero's (000).

- ▶ **Main Menu** → **CONTRLR CONFIG** → **PASSWORD** → press **OK**, to access password protection.
- ▶ Press the **Up/Down arrows** to select the numeric value, **Left/Right** arrows to move cursor, press **OK**.

Figure 4-14 - Password Protection



IMPORTANT: Make note of your password and save it.

4.2.9 Factory Reset

Selecting FACTORY RESET will revert all user settings to their factory, out of box, defaults. A confirmation screen will ask the user to confirm their intent since user settings will be lost and you will need to re-configure each channel. For this reason, record settings in each channel edit screen before performing a reset.

- ▶ *Main Menu* → *CONTRLR CONFIG* → *FACTORY RESET* → press *OK*, to perform a factory reset.
- ▶ Press *OK* to proceed; *X* to exit.

Figure 4-15 - Factory Reset

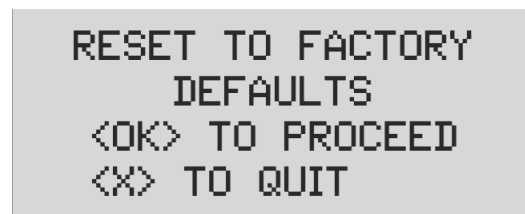

4.2.10 Update Firmware

When updated firmware is available, it can be installed via the SD card. Select 'SD EJECT' from the 'DATA LOGGING' menu and remove the SD card. Using a PC or Laptop, rename the new firmware image file to **MGS408.txt** and copy it onto the SD card. Re-install the SD card into its slot in the controller and select 'UPDATE FIRMWARE' from the 'CONTRLR CONFIG' menu. The new firmware will first be copied to flash memory, verified and moved to the application space followed by a reboot.

This process may take several minutes.

- ▶ *Main Menu* → *CONTRLR CONFIG* → *UPDATE FIRMWARE* → press *OK*, to perform a firmware update.
- ▶ Press *OK* to proceed; *X* to exit.

Figure 4-16 - Firmware Screen



```
CURRENT FIRMWARE IS  
REVISION 1.00  
Nov 5 2018  
14:48:33
```

Figure 4-17 - Firmware Reset

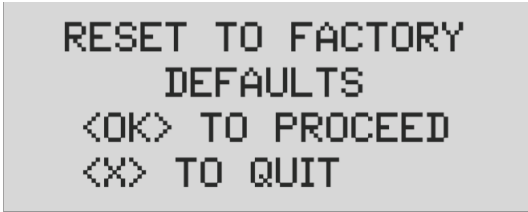

```
RESET TO FACTORY  
DEFAULTS  
<OK> TO PROCEED  
<X> TO QUIT
```

4.3. Channel Summary and Setup

Pressing a CH (X) key from the Channel Configuration screen will bring up a channel summary screen with detailed information collected from the gas detector assigned to that channel.

Figure 4-18 - Channel

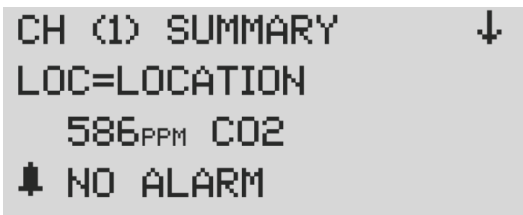

```
CH (1) SUMMARY      ↓  
LOC=LOCATION  
586PPM CO2  
↓ NO ALARM
```

4.3.1 Channel Setup Overview

Prior to setting channel parameters, the installer should verify and record the instrument type, node address and baud rate for each connected detector. All detectors must be set for the same baud rate, either 9600 (*default*) or 19200, and must have a unique node address. The MASTER BAUD setting in the MODBUS CONFIG menu must match the settings of the detectors.

- ▶ *Main Menu* → *CONTRLR CONFIG* → *CHANNEL(X)* → press *OK*, to access the channel configuration menu.

or

- ▶ Press *CH (X)* (twice) to turn monitoring for a channel on or off.



NOTE: Instructions for this section will use this shortcut.

For each detector channel there are four parameters the user may set; MON, TYP, ADR, LOC.

Figure 4-19 - Channel Setup

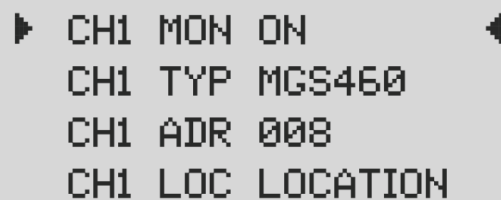

```
▶ CH1 MON ON ◀  
CH1 TYP MGS460  
CH1 ADR 008  
CH1 LOC LOCATION
```

4.3.2 CH(X) MON (Monitor)

This parameter set to ON or OFF, enables or disables the monitoring of the gas detector assigned to that channel. When set to ON, the controller will attempt to collect data, every five seconds, from the gas detector type and at the node address specified in the corresponding channel parameters. Successful communication will be indicated with a solid green LED next to the channel number key. Each time data is collected the LED will flicker to indicate communication access. Failed communication will be indicated by a blinking green LED and yellow system fault LED. Failed communication can be caused by a mismatch of either node address, instrument type or baud rate settings between the controller and the detector, or an detector without power. Setting the MON parameter to OFF will exclude the gas detector assigned to that channel from being scanned. If all channels have monitor parameters set to OFF, a system level fault will be triggered to indicate no detectors are being monitored.

- ▶ Press **CH (X)** (twice) → **MON (ON/OFF)** → press **OK**, to turn monitoring for a channel on or off.
- ▶ Press the **arrow keys** to select entry, press **OK**.

4.3.3 CH(X) TYP (Instrument Type)

The instrument type parameter indicates what instrument model is connected to CH(X). There are six supported instrument types; MGS250, MGS410, MGS450, MGS460, MGS550S1, MGS550S2. For MGS 550 models, the S1 and S2 designations specify, which of the two sensors connected, are to be assigned to CH(X).

- ▶ Press the **CH (X)** key (twice) → **CH(X) TYP MGS(X)** → press **OK**, to select the instrument type used for a channel:
- ▶ Press the **arrow keys** to select entry, press **OK**.

4.3.4 CH(X) ADR (Node Address)

Each connected detector must have a unique node address (*see detector instruction manual for how to set the detector node address*).

- ▶ Press the **CH (X)** key (twice) → **CH(X) ADR (XXX)** → press **OK**, to set the node address.
- ▶ Refer to the detector instruction manual for the correct setting for the detector node address, press the **arrow keys** to select the correct setting, press **OK**.



NOTE: Select the node address corresponding to the detector assigned to CH(X), valid addresses are 1-247.

4.3.5 CH(X) LOC (Location)

For each channel a 16-character string may be defined to describe the name or location of the detector assigned to that channel.

- ▶ Press the **CH (X)** key (twice) → **CH(X) LOC (Location)** → press **OK**, to set the location.
- ▶ Press the **Up/Down arrows** to select the value, **Left/Right arrows** to move cursor, press **OK**.



NOTE: This string will appear in the CHx detail summary screen as an aid to identify the location of the associated gas detector.

4.4. Data Logging

4.4.1 Data Logging Overview

With an SD card installed, the MGS-408 will log concentration, units of measure, gas name, low or high alarm state, detector fault code and controller fault code, every 10 seconds.

Log data is buffered for 10-minutes before writing to the SD card, so it is important to use the 'SD EJECT' menu item before removing the SD card, this will write the contents of the buffer and turn off data logging, so the card is ready to be removed. Log data is divided into weekly files using the naming convention MGS408_LOG_WEEK_XXX_OF_YYYY.csv, where XXX is the week number (1-52) and YYYY is the year. The file format is comma delimited text which can be opened directly in Microsoft Excel. Row 1 will contain a descriptive header for each column. The supplied 32Gb SD card can hold up to 10 years of log data.

4.4.2 SD Card Requirements

The MGS-408 comes with a 32 GB SD card installed, which can hold up to 10 years worth of log data. A compatible SD card will have 32 GB or less capacity and be formatted in the FAT32 format.

4.4.3 Data Logging Menu

From the data logging menu the user can safely eject the SD card, turn logging ON or OFF, view the percentage of free space remaining on the SD card, and view any current or historical fault codes.

Figure 4-20 - Data Logging Menu

```

▶ SD EJECT NO CARD ◀
LOGGING OFF
SD %FREE 0
↓ SD FAULT 08 ↓
  
```

4.4.3.1 SD EJECT

Select this option prior to removing the SD card. This will write any buffered log data to the card and turn off logging. Logging will automatically resume when the SD card is re-installed.

HRW Limited ▶ **Main Menu** → **DATA LOGGING** → **SD EJECT** → press **OK**, to safely eject an SD card. www.hrw.hk

4.4.3.2 LOGGING(ON/OFF)

Enable or disable data logging by setting this item to ON or OFF.

To enable/disable data logging:

- ▶ Press the arrow keys to select entry, press **OK**.

4.4.3.3 SD %FREE

Shows the percentage of space remaining on the installed SD card.

- ▶ **Main Menu** → **DATA LOGGING** press **OK**, to view **SD %FREE** and determine the percentage of space remaining.

4.4.3.4 SD FAULT (XX)

Any faults associated with the SD card will display as a two digit code next to this menu item, and selecting it will bring up a scrollable list of faults in English.

- ▶ **Main Menu** → **DATA LOGGING** → press **OK**, to view the fault codes:
- ▶ Press **OK** to select a fault and display a suggested remedy. SD card specific faults include:

• SD CARD MISSING	(01)	• SD FILE FAIL	(10)
• SD POWER FAIL	(02)	• SD WRITE FAIL	(20)
• SD CARD FULL	(04)	• SD CAP READ	(40)
• SD MOUNT FAIL	(08)	• SD WRITE PROTECT FAIL	(80)

4.4.3.5 LAST FLT (XX)

This item displays a two digit fault history code, and selecting it will bring up a scrollable list of faults, in English. Selecting a fault item will bring up a suggested remedy.

- ▶ **Main Menu** → **DATA LOGGING** → **LAST FLT** → press **OK**, to view a suggested fault remedy:
- ▶ Press the **Up/Down arrow** keys to select fault item, press **OK**.



NOTE: The code may be cleared from the diagnostic menu by selecting "**CLR LAST SDFault**".

5. MODBUS

5.1. MODBUS Overview

MODBUS RTU protocol is utilized both for down line detector communication and up line BMS communication. Communication parameters may be set from the MODBUS CONFIG menu.

The MGS-408 controller acts as a MODBUS master device on the detector side, and as a MODBUS slave device on the BMS side.

- ▶ Main Menu → MODBUS CONFIG → press OK to access the MODBUS CONFIG menu:

Figure 5-1 - MODBUS Menu

```
▶ MASTER BAUD 9600 ◀
  SLAVE NODE 001
    9600
  ↓ SLAVE PRTY NONE ↓
```

5.1.1 MASTER BAUD RATE

Slave devices (*gas detectors*) communicate with the master device (*MGS4088 Controller*) at this baud rate, either 9600 (*default*) or 19200.

- ▶ Main Menu → MODBUS CONFIG → MASTR BAUD → press OK, to change the *Master BAUD*.
- ▶ Press the *arrow keys* to select entry, press OK.

5.1.2 SLAVE NODE ADDRESS

This is the Modbus node address (1-247) that the upstream BMS will need to use when sending queries to the controller.

- ▶ Main Menu → MODBUS CONFIG → SLAVE NODE → press OK, to change the slave node address.
- ▶ Press the *Up/Down arrows* to select the value, *Left/Right arrows* to move cursor, press OK.

5.1.3 SLAVE BAUD RATE

The MGS-408 controller will use this baud rate to communicate with the upstream BMS or MODBUS master device, either 9600 (*default*) or 19200.

- ▶ *Main Menu* → *MODBUS CONFIG* → *SLAVE BAUD* → press **OK**, to change the *Slave BAUD*:
- ▶ Press the *arrow keys* to select entry, press **OK**.

5.1.4 SLAVE PARITY

This PARITY setting should match the BMS PARITY (*NONE, EVEN or ODD*).

- ▶ *Main Menu* → *MODBUS CONFIG* → *SLAVE PRTY (XXXX)* → press **OK**, to change the *Slave parity*.
- ▶ Press the *arrow keys* to select entry, press **OK**.

5.1.5 SLAVE STOP BIT

The number of stop bits (1 or 2) must match the BMS setting.

- ▶ *Main Menu* → *MODBUS CONFIG* → *SLAVE STOP (X)* → press **OK**, to stop bits.
- ▶ Press the *Up/Down arrow keys* to select entry, press **OK**.

5.1.6 SLAVE TERMINATION

A 120 ohm termination resistor can be enabled on the BMS connection. This is typically only required for cable lengths in excess of 1000', for shorter distances set this termination to OUT. The number of stop bits (*1 or 2*) must match the BMS setting.

- ▶ *Main Menu* → *MODBUS CONFIG* → *SLAVE TERM (X)* → press **OK**, to set the slave termination:
- ▶ Press the *arrow keys* to select entry, press **OK**.

5.2. MODBUS Registers

Read	Write	Register Address	Func Code 04 (read input registers)	Item Group	Notes
R	W	30001	Sensor 1 is monitored flag	Sensor 1	0=NOT MONITORED 1=MONITORED
R	X	30002	Sensor 1 communication status	Sensor 1	1=COM NORMAL, 2=COM FAIL
R	X	30003	Sensor 1 modbus error code	Sensor 1	Exception code from Modbus standard
R	X	30004	Sensor 1 concentration	Sensor 1	0-65535
R	X	30005	Sensor 1 status code	Sensor 1	0=OFFLINE 1=WARMUP 2=ONLINE
R	X	30006	Sensor 1 Fault code (<i>high byte</i>)	Sensor 1	Sensor specific
R	X	30007	Sensor 1 sensor fault code	Sensor 1	Sensor specific
R	X	30008	Sensor 1 ° C	Sensor 1	Sensor specific
R	X	30009	Sensor 1 Cal expired flag	Sensor 1	0=Cal Valid, 1=Cal expired
R	X	30010	Sensor 1 Low alarm flag	Sensor 1	0=No alarm, 1=Alarm
R	X	30011	Sensor 1 High alarm flag	Sensor 1	0=No alarm, 1=Alarm
R	X	30012	Sensor 1 Saturation flag	Sensor 1	0=Unsaturated, 1=Saturated
R	X	30013	Sensor 1 Underflow flag	Sensor 1	0=Normal, 1=Underflow
R	W	30014	Sensor 1 Instrument Type code	Sensor 1	0=MGS250, 1=MGS400, 2=MGS450, 3=MGS460, 4=MGS550-S1, 5=MGS550-S2
R	W	30015	Sensor 1 Node Address	Sensor 1	1-254
R	X	30016	Sensor 1 Sensor Type code	Sensor 1	Sensor specific
R	X	30017	Sensor 1 Concentration Units	Sensor 1	1=ppm, 2=ppb, 3=%VOL, 4=%LEL

Read	Write	Register Address	Func Code 04 (read input registers)	Item Group	Notes
R	X	30018	Sensor 1 Scale Factor	Sensor 1	Power of 10 used on concentration, divide conc by 10 ^x for correct value (MGS-550 only)
R	X	30019	Sensor 1 Gas Type Text Char 1,2	Sensor 1	ASCII characters
R	X	30020	Sensor 1 Gas Type Text Char 3,4	Sensor 1	ASCII characters
R	X	30021	Sensor 1 Gas Type Text Char 5,6	Sensor 1	ASCII characters
R	X	30022	Sensor 1 Gas Type Text Char 7,8	Sensor 1	ASCII characters
R	X	30023	Sensor 1 Gas Type Text Char 9,10	Sensor 1	ASCII characters
R	X	30024	Sensor 1 SID Text Char 1,2	Sensor 1	ASCII characters
R	X	30025	Sensor 1 SID Text Char 3,4	Sensor 1	ASCII characters
R	X	30026	Sensor 1 SID Text Char 5,6	Sensor 1	ASCII characters
R	X	30027	Sensor 1 SID Text Char 7,8	Sensor 1	ASCII characters
R	X	30028	Sensor 1 UID Text Char 1,2	Sensor 1	ASCII characters
R	X	30029	Sensor 1 UID Text Char 3,4	Sensor 1	ASCII characters
R	X	30030	Sensor 1 UID Text Char 5,6	Sensor 1	ASCII characters
R	X	30031	Sensor 1 UID Text Char 7,8	Sensor 1	ASCII characters
R	X	30032	Sensor 1 Alias Text Char 1,2	Sensor 1	ASCII characters
R	X	30033	Sensor 1 Alias Text Char 3,4	Sensor 1	ASCII characters
R	X	30034	Sensor 1 Alias Text Char 5,6	Sensor 1	ASCII characters
R	X	30035	Sensor 1 Alias Text Char 7,8	Sensor 1	ASCII characters
R	X	30036	Sensor 1 Alias Text Char 9,10	Sensor 1	ASCII characters
R	X	30037	Sensor 1 Alias Text Char 11,12	Sensor 1	ASCII characters
R	X	30038	Sensor 1 Alias Text Char 13,14	Sensor 1	ASCII characters
R	X	30039	Sensor 1 Alias Text Char 15,16	Sensor 1	ASCII characters
R	X	30051-30100	SENSOR 2 DATA GROUP (REPEAT OF SENSOR1)	Sensor 2	
R	X	300101-30150	SENSOR 3 DATA GROUP (REPEAT OF SENSOR1)	Sensor 3	

Read	Write	Register Address	Func Code 04 (read input registers)	Item Group	Notes
R	X	30151-30200	SENSOR 4 DATA GROUP (REPEAT OF SENSOR1)	Sensor 4	
R	X	30201-30250	SENSOR 5 DATA GROUP (REPEAT OF SENSOR1)	Sensor 5	
R	X	30251-30300	SENSOR 6 DATA GROUP (REPEAT OF SENSOR1)	Sensor 6	
R	X	30301-30350	SENSOR 7 DATA GROUP (REPEAT OF SENSOR1)	Sensor 7	
R	X	30351-30400	SENSOR 8 DATA GROUP (REPEAT OF SENSOR1)	Sensor 8	
R	X	31000	Sensor 1 Concentration	Sensor 1	
R	X	31001	Sensor 2 Concentration	Sensor 2	
R	X	31002	Sensor 3 Concentration	Sensor 3	
R	X	31003	Sensor 4 Concentration	Sensor 4	
R	X	31004	Sensor 5 Concentration	Sensor 5	
R	X	31005	Sensor 6 Concentration	Sensor 6	
R	X	31006	Sensor 7 Concentration	Sensor 7	
R	X	31007	Sensor 8 Concentration	Sensor 8	
R	X	31032	Sensor 1 Fault code (high bytes)	Sensor 1	
R	X	31033	Sensor 1 Fault code	Sensor 1	
R	X	31034	Sensor 2 Fault code (high bytes)	Sensor 2	
R	X	31035	Sensor 2 Fault code	Sensor 2	
R	X	31036	Sensor 3 Fault code (high bytes)	Sensor 3	
R	X	31037	Sensor 3 Fault code	Sensor 3	
R	X	31038	Sensor 4 Fault code (high bytes)	Sensor 4	
R	X	31039	Sensor 4 Fault code	Sensor 4	
R	X	31040	Sensor 5 Fault code (high bytes)	Sensor 5	
R	X	31041	Sensor 5 Fault code	Sensor 5	
R	X	31042	Sensor 6 Fault code (high bytes)	Sensor 6	

Read	Write	Register Address	Func Code 04 (read input registers)	Item Group	Notes
R	X	31043	Sensor 6 Fault code	Sensor 6	
R	X	31044	Sensor 7 Fault code (high bytes)	Sensor 7	
R	X	31045	Sensor 7 Fault code	Sensor 7	
R	X	31046	Sensor 8 Fault code (high bytes)	Sensor 8	
R	X	31047	Sensor 8 Fault code	Sensor 8	
R	W	40002	RS-485 Node Address	Controller-related	1-254
R	W	40003	Baud Rate	Controller-related	0=9600 1=19200
R	W	40004	Stop Bits	Controller-related	1 or 2
R	W	40005	Parity	Controller-related	0=none 1=odd 2=even
R	W	40006	Controller UID Char 1,2	Controller-related	ASCII characters
R	W	40007	Controller UID Char 3,4	Controller-related	ASCII characters
R	W	40008	Controller UID Char 5,6	Controller-related	ASCII characters
R	W	40009	Controller UID Char 7,8	Controller-related	ASCII characters
R	X	40010	16 bit Current Fault Code Controller	Controller-related	0-65535
R	X	40011	16 bit Last Fault Code Controller	Controller-related	0-65535
R	X	40012	Software Version Controller	Controller-related	X100
R	W	40013	Relay 1 Contact Behavior / Failsafe	Controller-related	0=normal 1=Failsafe
R	W	40014	Relay 2 Contact Behavior / Failsafe	Controller-related	0=normal 1=Failsafe
R	W	40015	Relay 3 Contact Behavior / Failsafe	Controller-related	0=normal 1=Failsafe
R	X	40016	24V supply voltage x 100	Diagnostics	2400=24.00V

Read	Write	Register Address	Func Code 04 (read input registers)	Item Group	Notes
R	X	40017	24V supply output to sensors voltage x 100	Diagnostics	2400=24.00V
R	X	40018	Battery voltage x 100	Diagnostics	300=3.0V
R	X	40019	Controller 5V supply voltage x100	Diagnostics	500=5.00V
R	X	40020	Controller 3.3V supply voltage x100	Diagnostics	330=3.30V
R	X	40021	Controller temperature x100	Diagnostics	2500=25.00degC
R	X	40022	Controller tact and mag switch state	Diagnostics	Sum of activated switch values
R	W	40023	Buzzer enable	Controller-related	0=Disabled 1=enabled
R	W	40024	Data Logging Enabled	Controller-related	0=Disabled 1=enabled
R	W	40025	Fault Latching Enabled	Controller-related	0=Disabled 1=enabled

Read	Write	Register Address	Func Code 03/06 (read/preset)	Item Group	Notes
R	X	40020	Controller 3.3V supply voltage x100	Diagnostics	330=3.30V
R	X	40021	Controller temperature x100	Diagnostics	2500=25.00degC
R	X	40022	Controller tact and mag switch state	Diagnostics	Sum of activated switch values
R	W	40023	Buzzer enable	Controller-related	0=Disabled 1=enabled
R	W	40024	Data Logging Enabled	Controller-related	0=Disabled 1=enabled
R	W	40025	Fault Latching Enabled	Controller-related	0=Disabled 1=enabled

Read	Write	Register Address	Func Code 02 (read input status)	Type	Item Group
R	X	10001	Sensor 1 Low Alarm Flag (0 or 1 = alarm)		Sensor 1
R	X	10002	Sensor 2 Low Alarm Flag (0 or 1 = alarm)		Sensor 2
R	X	10003	Sensor 3 Low Alarm Flag (0 or 1 = alarm)		Sensor 3
R	X	10004	Sensor 4 Low Alarm Flag (0 or 1 = alarm)		Sensor 4
R	X	10005	Sensor 5 Low Alarm Flag (0 or 1 = alarm)		Sensor 5
R	X	10006	Sensor 6 Low Alarm Flag (0 or 1 = alarm)		Sensor 6
R	X	10007	Sensor 7 Low Alarm Flag (0 or 1 = alarm)		Sensor 7
R	X	10008	Sensor 8 Low Alarm Flag (0 or 1 = alarm)		Sensor 8
R	X	10033	Sensor 1 High Alarm Flag (0 or 1 = alarm)		Sensor 1
R	X	10034	Sensor 2 High Alarm Flag (0 or 1 = alarm)		Sensor 2
R	X	10035	Sensor 3 High Alarm Flag (0 or 1 = alarm)		Sensor 3
R	X	10036	Sensor 4 High Alarm Flag (0 or 1 = alarm)		Sensor 4
R	X	10037	Sensor 5 High Alarm Flag (0 or 1 = alarm)		Sensor 5
R	X	10038	Sensor 6 High Alarm Flag (0 or 1 = alarm)		Sensor 6
R	X	10039	Sensor 7 High Alarm Flag (0 or 1 = alarm)		Sensor 7
R	X	10040	Sensor 8 High Alarm Flag (0 or 1 = alarm)		Sensor 8
R	X	10065	Sensor 1 Any Alarm Flag (0 or 1 = alarm)		Sensor 1
R	X	10066	Sensor 2 Any Alarm Flag (0 or 1 = alarm)		Sensor 2
R	X	10067	Sensor 3 Any Alarm Flag (0 or 1 = alarm)		Sensor 3
R	X	10068	Sensor 4 Any Alarm Flag (0 or 1 = alarm)		Sensor 4
R	X	10069	Sensor 5 Any Alarm Flag (0 or 1 = alarm)		Sensor 5
R	X	10070	Sensor 6 Any Alarm Flag (0 or 1 = alarm)		Sensor 6
R	X	10071	Sensor 7 Any Alarm Flag (0 or 1 = alarm)		Sensor 7
R	X	10072	Sensor 8 Any Alarm Flag (0 or 1 = alarm)		Sensor 8
R	X	10097	Sensor 1 Fault Flag (0 or 1 = fault)		Sensor 1
R	X	10098	Sensor 2 Fault Flag (0 or 1 = fault)		Sensor 2
R	X	10099	Sensor 3 Fault Flag (0 or 1 = fault)		Sensor 3
R	X	10100	Sensor 4 Fault Flag (0 or 1 = fault)		Sensor 4
R	X	10101	Sensor 5 Fault Flag (0 or 1 = fault)		Sensor 5
R	X	10102	Sensor 6 Fault Flag (0 or 1 = fault)		Sensor 6
R	X	10103	Sensor 7 Fault Flag (0 or 1 = fault)		Sensor 7
R	X	10104	Sensor 8 Fault Flag (0 or 1 = fault)		Sensor 8
R	W	10129	Sensor 1 enabled flag (0=disabled 1=enabled)		Sensor 1
R	W	10130	Sensor 2 enabled flag (0=disabled 1=enabled)		Sensor 2

Read	Write	Register Address	Func Code 02 (read input status)	Type	Item Group
R	W	10131	Sensor 3 enabled flag (0=disabled 1=enabled)		Sensor 3
R	W	10132	Sensor 4 enabled flag (0=disabled 1=enabled)		Sensor 4
R	W	10133	Sensor 5 enabled flag (0=disabled 1=enabled)		Sensor 5
R	W	10134	Sensor 6 enabled flag (0=disabled 1=enabled)		Sensor 6
R	W	10135	Sensor 7 enabled flag (0=disabled 1=enabled)		Sensor 7
R	W	10136	Sensor 8 enabled flag (0=disabled 1=enabled)		Sensor 8
R	X	10200	Relay 1 State (0 or 1 = energized)		Controller-related
R	X	10201	Relay 2 State (0 or 1 = energized)		Controller-related
R	X	10202	Relay 3 State (0 or 1 = energized)		Controller-related

Read	Write	Register Address	Func Code 01/05 (Read/force coil)	Type	Item Group
		00004	Relay Closed Test. Setting this flag to one closes all 3 relays simultaneously for 5 seconds. At the end of the test the relays revert to their normal operation. During the test the Modbus flag will remain ON. When the test is completed the flag will turn OFF	DYN	
		00005	Relay Opened Test. Setting this flag to one opens all 3 relays simultaneously for 5 seconds. At the end of the test the relays revert to their normal operation. During the test the Modbus flag will remain ON. When the test is completed the flag will turn OFF		
R	X	0x00	Vendor name "Bacharach"	STA	Controller-related
R	X	0x01	Product code "MGS-408"	STA	Controller-related
R	X	0x02	Major minor rev "NN.nn"	STA	Controller-related

Read	Write	Register Address	FUNC CODE 43/14 (Device ID Read Only)	Type	Item Group
R	X	0x00	Vendor name "Bacharach"	STA	Controller-related
R	X	0x01	Product code "MGS-408"	STA	Controller-related
R	X	0x02	Major minor rev "NN.nn"	STA	Controller-related

6. Diagnostics & Troubleshooting

6.1. Diagnostic Menu

From the diagnostic menu the user can review and clear current and historical faults, view power supply voltages, and watch live Modbus traffic for both master, slave and Bluetooth connections. The diagnostic menu appears on the second page of the main menu.

- ▶ *Main Menu* → *DIAGNOSTICS* → press *OK*, to access the Diagnostic menu:

Figure 6-1 - Diagnostic Menu

```
▶ CURRENT FAULT ◀  
  LAST FAULT  
  CLEAR FAULT  
↓ CLEAR LAST FAULT ↓
```

6.1.1 DISPLAY CURRENT FAULT

Displays the current active controller fault code along with a list of fault descriptors.

- ▶ *Main Menu* → *DIAGNOSTICS* → *CURRENT FAULT* → press *OK*, to access the current active controller fault code.
- ▶ Use the *Up/Down arrows* to select a descriptor, then press *OK* for more detailed information about the fault and possible remedies.

Figure 6-2 - Current Fault

```
▶ FAULT CODE=1C00 ◀  
  CONFIG ERROR  
  SD CARD ERROR  
  SENSOR RESPONSE
```

6.1.2 DISPLAY LAST FAULT

Displays historical fault code and listing. Intermittent fault conditions can be reviewed here.

- ▶ **Main Menu** → **DIAGNOSTICS** → **LAST FAULT** → press **OK**, to access review fault conditions.
- ▶ Use the **Up/Down arrows** to select a fault descriptor, then press **OK** for more detailed information about the fault and possible remedies.

6.1.3 CLEAR FAULT

Resets the current active fault code to zero (no faults). Use to clear faults when see FAULT LATCHING is enabled. See "Fault Latching" on page 18 for further information.

- ▶ **Main Menu** → **DIAGNOSTICS** → **CLEAR FAULT** → press **OK** twice, to reset the active fault code:

6.1.4 CLEAR LAST FAULT

Resets the historical last fault code to zero. Use to find recurring intermittent fault conditions.

- ▶ **Main Menu** → **DIAGNOSTICS** → **CLEAR LAST FAULT** → press **OK** twice, to reset the last fault code.

6.1.5 CLEAR LAST SD FAULT

Resets the historical SD card fault code. Use to find recurring intermittent fault conditions with the SD card or data logging.

- ▶ **Main Menu** → **DIAGNOSTICS** → **CLR LAST SD FAULT** → press **OK** twice, to reset the **SD fault** code.

6.1.6 POWER

Displays live power supply voltages and chassis temperature. Use when a SUPPLY VOLTS ERR or CHASSIS TEMP HI is indicated as a fault.

- ▶ **Main Menu** → **DIAGNOSTICS** → **POWER** → press **OK**, to view power supply voltage information:

Voltage tolerances are as follows:

- SUPPLY IN=24 V \pm 3
- SUPPLY OUT=24 V \pm 3
- 5V=5V \pm 0.3
- 3.3V=3.3V \pm 0.3 V
- BAT= 1.8V to 3.6 V (*Coin cell voltage*)
- T =60 to -20deg C (*Internal chassis temperature*)

6.1.7 MODBUS SLAVE

Displays the live Modbus traffic for the BMS connection. Use when troubleshooting communication problems with upstream master devices.

- ▶ *Main Menu* → *DIAGNOSTICS* → *MODBUS SLAVE* → press *OK*, to clear the screen and view the next query and response.

For each query received by the controller from a master device or BMS, the number of bytes transmitted TX=, the function code used FUNC=, the register address requested ADDR=, and any errors or exceptions on the bottom line.

6.1.8 MODBUS MASTER

Displays the live Modbus traffic for each channel. Use when troubleshooting communication problems with detectors on the slave network.

- ▶ *Main Menu* → *DIAGNOSTICS* → *MODBUS MASTER* → press *OK*, to troubleshoot *MODBUS* communication problems: .
- ▶ Use the *Up/Down* arrows to switch channel numbers, then press *OK* to clear the screen to view the next query and response.

For each query sent by the controller the number of bytes transmitted TX=, the function code used FUNC=, the register address requested ADDR=, and any errors or exceptions on the bottom line.

6.2. FAULT CODES

Code	Critical Fault	Possible Causes	Remedy
0001	CHASSIS TEMP HI	Chassis temperature outside the range of -20 to 60° C	Reduce ambient temperature or check for power supply malfunction.
0002	RS485 MSTR BUFR	Buffer overflow communicating with detectors	Disable all but one channel, use MODBUS MASTER traffic screen to one CH at a time.
0004	RS485 SLAVE BUFR	Buffer overflow communicating with BMS	Use MODBUS SLAVE traffic screen to diagnose.
0008	RS485 MSTR CRC	CRC error communicating with detectors	Disable all but one channel, use MODBUS MASTER traffic screen to one CH at a time.
0010	RS485 SLAVE CRC	CRC error communicating with BMS	Use MODBUS SLAVE traffic screen to diagnose.
0020	BT SLAVE CRC	CRC error communicating with Bluetooth APP	Use BLUETOOTH traffic screen to diagnose.
0040	RS485 SL TMOU	Modbus timeout communicating with BMS	Use MODBUS SLAVE traffic screen to diagnose.
0080	BLE EEPROM	Error configuring Bluetooth transceiver	Reset, or Reboot controller, if fault persists, consult factory.
0100	BT SLAVE BUF	Buffer overflow communicating with Bluetooth APP	Use MODBUS SLAVE traffic screen to diagnose.
0200	STUCK KEY ERROR	On or more keys on the keypad are stuck down	Use KEYPAD TEST to determine stuck key, consult factory.
0400	CONFIG ERROR	All detectors are disabled or there are duplicate node addresses	Enable one or more channels, or check for duplicate node address assignment.
0800	SD CARD ERROR	SD card interface is reporting an error (<i>see section X.X.X</i>)	Select SD FAULT from DATA LOGGING menu for details.
1000	SENSOR RESPONSE	One or more detectors are not responding to queries	Disable all but one channel, use MODBUS MASTER traffic screen to test one CH at a time.
2000	SUPPLY VOLTS ERR	One or more power supply voltages are out of range	Check POWER screen in diagnostic menu, if SUPPLY OUT is <23.7V check for short or overload on detector supply feed. If battery voltage is less than 1.8V replace coin cell. Otherwise consult factory.

Code	Critical Fault	Possible Causes	Remedy
4000	CPU ERROR	Microcontroller malfunction	Reset or reboot controller, if fault persist, consult factory.
8000	EEPROM ERROR	EEPROM malfunction	Consult factory.

6.3. SYSTEM TESTS

- ▶ *Main Menu* → *SYSTEM TESTS* → press *OK*, to access the system tests menu.

To facilitate installation and troubleshooting the following test are available from the *SYSTEM TEST* menu.

6.3.1 RELAY TEST

- ▶ *Main Menu* → *SYSTEM TESTS* → *RELAY TEST* → press *OK*, To access the relay test: .
- ▶ Manually toggle each relay using the CH key indicated.

6.3.2 LED TEST

- ▶ *Main Menu* → *SYSTEM TESTS* → *LED TEST* → press *OK*, to access the LED test.
- ▶ Press *OK*; all front panel LEDs should illuminate.

6.3.3 KEYPAD TEST

- ▶ *Main Menu* → *SYSTEM TESTS* → *KEYPAD TEST* → press *OK*, to access the keypad test.
- ▶ Press a *CH key*; designation will be indicated on the screen for each key pressed.

6.3.4 STROBE TEST

- ▶ *Main Menu* → *SYSTEM TESTS* → *STROBE TEST* → press *OK*, to access the strobe test.
- ▶ Press the *Up/Down arrows* to manually toggle the strobe, if installed.

6.3.5 FAN TEST

- ▶ *Main Menu* → *SYSTEM TESTS* → *FAN TEST* → press *OK*, to access the fan test.
- ▶ Press the *Up/Down arrows* to manually toggle the chassis cooling fan.

7. Additional Information

7.1. Disposing of Instrument

EU-wide regulations governing the disposal of electrical and electronic appliances which have been defined in the EU Directive 2012/19/EU and in national laws have been effective since August 2012 and apply to this device.

Common household appliances can be disposed of using special collecting and recycling facilities. However, this device has not been registered for household usage. Therefore it must not be disposed of through these channels. The device can be returned to your national Bacharach Sales Organization for disposal. Contact Bacharach if you have any questions.

7.2. Technical Specifications

Model	Load (W)
Number of Channels	1-8
Display	4 × 20 LCD w/ Backlight
Ambient Temperature Range	-20 to +50° C
Power Supply	100-240 VAC 80 W max
Power Output	24 VDC 51 W max

8. Parts and Accessories

8.1. Part Numbers

MGS-408 Configurations

Part #	Description
6702-8000	MGS-408 gas detection controller, 8 channels

MGS-400 Series Accessories

Part #	Description
1100-2307	Optional strobe, mounts directly onto MGS-408, red lens
1100-2308	Optional strobe, mounts directly onto MGS-408, green lens
1100-2309	Optional strobe, mounts directly onto MGS-408, blue lens
1100-2310	Optional strobe, mounts directly onto MGS-408, yellow lens
3015-8046	External Beacon; red lens; MP120K 120V AC adapter
3015-8047	External Beacon; green lens; MP120K 24V AC adapter
3015-8048	External Beacon; red lens; MPK120K 120V AC adapter

8.2. Service Center Locations

Prior to shipping equipment to Bacharach, visit www.mybacharach.com for a Returned Merchandise Authorization Number (RMA #). All returned goods must be accompanied by a RMA #. Pack the equipment securely (*in its original packing, if possible*), as Bacharach cannot be held responsible for any damage incurred during shipping to our facility.

Location	Contact Information	Shipping Address
United States	Phone: +1 724 334 5000 Toll Free: +1 800 736 4666 Fax: +1 724 334 5001 Email: help@mybacharach.com	Bacharach, Inc. 621 Hunt Valley Circle New Kensington, PA 15068, USA ATTN: Service Department
Europe	Phone: +353 1 284 6388 Fax: +353 1 284 6389 Email: help@mybacharach.com	Bacharach, Inc. Unit D12 & D13 Santry Business Park, Swords Road Santry, Dublin, Ireland ATTN: Service Department
Canada	Phone: +1 905 882 8985 Fax: +1 905 882 8963 Email: support@bachcan.ca	Bacharach, Inc. 10 West Pearce Street, Unit 4 Richmond Hill, Ontario. L4B 1B6, Canada ATTN: Service Department



THIS PAGE LEFT BLANK INTENTIONALLY.



THIS PAGE LEFT BLANK INTENTIONALLY.



THIS PAGE LEFT BLANK INTENTIONALLY.



THE MEASURABLE DIFFERENCE

Bacharach, Inc.
621 Hunt Valley Circle,
New Kensington, PA 15068 USA

HRW Limited | Pittsburgh, PA USA | Dublin, IRE | Stanardsville, VA USA | Toronto, CAN
www.mybacharach.com | admin@hrw.com | help@mybacharach.com | www.hrw.hk