



HPC0662P1 Universal Controller, P1 FLN

FW4.02

12 point, eight control loop, peer-to-peer DDC controller with high flexibility for user configuration to suit a wide variety of HVAC or universal applications in P1 FLN networks or standalone.

Versatile I/O, selection of multiple control loops, digital function blocks and analogue function blocks allow easy configuration for control of FCU and AHU with multiple control loops, signal processing or conversion and – when networked – remote I/O expansion.

Predefined logic function blocks enable easy configuration of a variety of functions including Economy Changeover (temperature or enthalpy), VAV Volume, Occupancy, Hours Run monitoring, Minutes Run monitoring, Lead/Lag changeover, instantaneous Power calculation (kW, BTU) and a wide array of hysteresis & dead-band/live-band choices (Compare function).

Typical Applications

- Temperature, humidity, pressure, IAQ, etc
- Modulating, 3-point floating, on/off, PWM (Pulse Width Modulation), step control, DX
- Signal selection, signal conversion
- Pulse counting

Feature Summary

- 4 Digital Outputs (DO) with power-up presetting & short-cycle timers
- 6 Universal Inputs (UI - user configurable analogue [AI] or digital [DI n/o or n/c], flip/flop, pulse-counting up to 10Hz)
- 2 Universal Outputs (UO – jumper select DO or AO) with power up presetting
- RJ11 socket connection of HSD0012 or HSD0011 room sensors to UI1 & UI2 (room sensor with set point adjuster option, occupancy button & HPECOM port)
- 8 Virtual Digital Inputs (VDI)
- 8 Virtual UI's (VUI)
- 8 Digital Logic blocks (DL)
- 8 Analogue Logic blocks (AL)
- 8 PI Control Loop blocks (CL)
- UI's user scalable and units user settable (C, F, rH, %, Pa, kPa, PPM, etc.)
- Connected sensors may be calibrated and filtered by way of the UI configuration
- Isolated, 256 node (1/8th load), RS485 network driver
- Communication speeds from 2400 baud up to 76800 baud
- LED indication of the On/Off status of DI and DO points for fast visual status verification
- Dynamic LED indication of AO status
- Automatic communication resumption after a power loss
- PC configuration by text file download using FUNCPROG or by direct parameter settings entry
- Upload text file data for retrieving lost application settings, for re-use in other controllers



OPERATION OVERVIEW	3
APPLICATION NUMBER 162	4
POINT TYPES	4
FUNCTION BLOCK POINTS & SUB-PARAMETERS	5
TERMINAL MODE	7
HYPERTERMINAL SETTINGS	7
<i>Additional Settings</i>	8
<i>Connecting at 76800 Baud Rate</i>	8
<i>Saving HyperTerminal Settings</i>	8
<i>Changing Baud Rate</i>	8
BREAK IN TO TERMINAL MODE	9
ADMINISTRATION COMMANDS	10
DISPLAY NAVIGATION	10
SUMMARY SCREEN SETTING	11
MANUAL OVERRIDE / RELEASE	11
OPERATIONAL DISPLAYS	12
USER SUMMARY SCREEN	12
DOWNLOAD TEXT FILE	13
‘MAIN’ PHYSICAL I/O DISPLAY	14
POINT LIST DISPLAY	14
CONTROL LOOP (CL) DISPLAY	15
DIGITAL LOGIC (DL) & ANALOGUE LOGIC (AL) DISPLAY	16
RESET TO FACTORY DEFAULT	17
UPLOAD TEXT FILE	17
UNIVERSAL INPUTS	18
LINEARISATION TABLE	19
FACTORY DEFAULT SENSOR TYPES	19
ACTIVE SENSOR SCALINGS	19
PASSIVE SENSOR DEFINITION	20
RESET TO FACTORY DEFAULT	20
INSTALLATION & COMMISSIONING	21
CONNECTIONS	22
DIMENSIONS	22
TECHNICAL DATA	23
ORDERING INFORMATION	24
HPC0662P1	24
ACCESSORIES	24
OTHER HP_P1 SERIES DEVICES	24
DOCUMENT UPDATE HISTORY	25



Operation Overview

All physical inputs, outputs and internal logic & control function blocks, and critical control loop parameters are numerically represented as a 'point'. The point is a function block's output value. Depending on the purpose of a function block the point may have a range of sub-parameters available for defining the block's function and the operational features & limitations of the function. In the case of control loops the active set point, the proportional band and the integral time parameters are also represented as points for network access and remote tuning of a control loop if required.

The process of setting up function blocks and connecting function blocks to form an application uses simple text lines therefore it is not necessary to learn a complex programming language. The settings may be manually typed in to the device or, using the **FUNCPROG 141101** programming tool which provides a visual representation of each block, an application text file may be created, saved and downloaded to the device as a complete group of settings. Earlier versions of FuncProg may be used but the latest feature settings will not be directly available in those earlier versions.

The ability to make single setting changes directly at the device makes for easy debugging and commissioning.

The function blocks comprise:

- Physical I/O for connection of input switches, sensors and output control devices
- Virtual inputs for taking over external commands and values from other network devices or for manual settings and overrides
- Logic blocks for event based reactions and influences
- PI Control Loop blocks for set point based control reactions
- Network settings

In all cases points may be manually overridden for testing & commissioning purposes or for service override.

Connection to the device for programming and service is via a terminal program such as HyperTerminal (recommended). While on-line to the device it is possible to view point statuses and where applicable, any dependent or influencing point's connections. Statuses are updated live to the terminal screen every 10 seconds or manually refreshed any time by pressing the enter key.

In addition to the predefined point displays a user-defined display is available for a customised point summary related to an application. The user display may contain up to 32 lines of user text with or without dynamic points included.



Application Number 162

The default application number is 162. If necessary it is possible to change the application number while in terminal mode with the command `AN=nnnnn`

Point Types

A total of 92 function blocks exist in the device. Many points may be Digital or Analogue, therefore it is necessary to consider the programmed use of an input or an output before deciding it's point type.

Example, DO1

Description:	Physical digital output
Point #:	9
Type when on/off DO:	LDO
Type when PWM DO:	LAO

Example, AL1

Description:	Analogue Logic block
Point #:	53
Type when Digital function:	LDI
Type when Analogue function:	LAI



Function Block Points & Sub-Parameters

The following is an overview of the function block features and options. For in-depth description of function choices and their use please also download or request the separate **FUNCPROG Application Tool** document.

Function Block	Point	Para #	Description	Selection Options		
Digital Output 1...4 + 5 & 6 (UO, jumper selected)	9...14	(x)x00=	OR1	Point #		
		(x)x01=	OR2	Point #		
		(x)x02=	AND	Point #		
		(x)x03=	PWM cycle time (sec)	0...255		
		(x)x04=	ON	% of control loop demand		
		(x)x05=	OFF	% of control loop demand		
		(x)x06=	Minimum ON time (sec)	0...255		
		(x)x07=	Minimum OFF time (sec)	0...255		
		(x)x08=	Maximum Run time (sec)	0...1000		
		(x)x09=	Remember last state at power return	0 - Disable, 1 Enable		
Universal Input 1...6	17...22			0 - 100k NTC (-10...90°C) [Ctc] 1 - Ni1000 (-10...90°C) <i>not used</i> 2 - 0-10Vdc (0...100%) [%V1] 3 - 4...20mA (0...100%) [%mA] 4 - PT1000 (-10...90°C) <i>not used</i> 5 - 10k NTC (-10...90°C) [Ctx] 6 - Pulse counter [P] 7 - Digital [D] 8 - % (0-100%) [%] 9 - Seconds [Sec] 14 - Digital normally-closed [DNC] 15 - Toggle on/off [D T]		
		xx00=	Sensor type			
		xx01=	Input calibration - Offsets the measured value up to 10% of the sensor range	Any value within 10% of the sensor range		
		xx02=	Filter incoming sensor measurement when the connected sensor is unstable	0 - Minimum (factory default) 1...9 - User setting where 9 represents the maximum filtering sample time For unstable sensors then a setting of 1 or 2 will typically be enough filtering to result in a stable measurement		
		xx03=	Output OR*	Point #		
		xx04=	Output AND*	Point #		
		xx00=	OR1	Point #		
		xx01=	OR2	Point #		
		xx02=	AND	Point #		
		xx03=	100%	% of control loop demand		
		xx04=	0%	% of control loop demand		
		Analogue Output 1 & 2 (UO, jumper selected)	25...26	x01=	Output OR	Point #
				x02=	Output AND	Point #
				xx00=	Function	OR, NOR, AND, NAND, XOR, NXOR, Lead/Lag
		Virtual Digital Input 1...8	29...36	xx01=	Input1	Point #
xx02=	Input2			Point #		
xx03=	Input3			Point #		
xx04=	Input4			Point #		
xx05=	Delay On			0...44 or 53...65,535 sec,		
xx06=	Delay Off			or Point # 45...52 for remote settable		
xx07=	Output OR*			Point #		
xx08=	Output AND*			Point #		
xx09=	Occupancy push button			Point #		
xx00=	Set sensor type			Same as UI selection Type 0... 9, 10 - Hours Run, 11 - Minutes Run		
Virtual Univ. Input 1...8	45...52	xx01=	Output OR*	Point #		
		xx02=	Output AND*	Point #		

* Digital 1 = 1000 (100%) when applied to these analogue logic functions. Analogue values will act as an Output Minimum when applied to an Output OR and Output Maximum when applied to an Output AND.



Function Block	Object	Para #	Setting Selection	Selection Options
Analogue Logic 1...8	53...60	xx00=	Function	Max, Min, Avg, Signal-Select, +, -, *, /, or Eco-Changeover, Proportion, VAV Volume, Up/Down counter, Power, Compare
		xx01=	Set output-relevant sensor type	Same as UI selection
		xx02=	Input1	Point #
		xx03=	Input2	Point #
		xx04=	Input3	Point #
		xx05=	Input4	Point #
		xx06=	Offset	Relative value
		xx07=	Value In 1	Shift input start value
		xx08=	Value Out 1	Shifted output minimum value
		xx09=	Value In 2	Shift input stop value
		xx10=	Value Out 2	Shifted output maximum value
		xx11=	Output OR *	Point #
		xx12=	Output AND *	Point #
Control Loops 1...8	61...68	Read only	Set point	Absolute value
		xx00=	Start/Stop (Dig/Analogue)	Point #
	69...76	xx01=	Input (Analogue)	Point #
		xx02=	Occupied Setpoint	Absolute value
		xx03=	Unoccupied Setpoint	Absolute value
		xx04=	Protection Setpoint	Absolute value
		xx05=	SetPoint Deadband	Relative value
		xx06=	Setpoint Max.	Absolute value
		xx07=	Setpoint Min.	Absolute value
		xx08=	Output action	0 – Direct, 1 – Reverse, 2 – Direct 50, 3 – Reverse 50
77...84	xx09=	Output OR *	Point #	
	xx10=	Output AND *	Point #	
77...84	xx=	Proportional Band	Absolute value based on related sensor range	
85...92	xx=	Integral time	0...1000 Seconds	

* Digital 1 = 1000 (100%) when applied to these analogue logic functions. Analogue values will act as an Output Minimum when applied to an Output OR and Output Maximum when applied to an Output AND.

Terminal Mode

The HPECOMU data cable with USB connection is used for terminal mode between the device and a PC running a terminal program. HyperTerminal is recommended. The driver for the HPECOMU cable may be downloaded from www.hrw.hk, Resources / Tools, section.

HyperTerminal Settings

For successful communication between HyperTerminal and the device, initial Properties setup of HyperTerminal should be as per the screen prints below.

'Connect to' Comm Configuration:

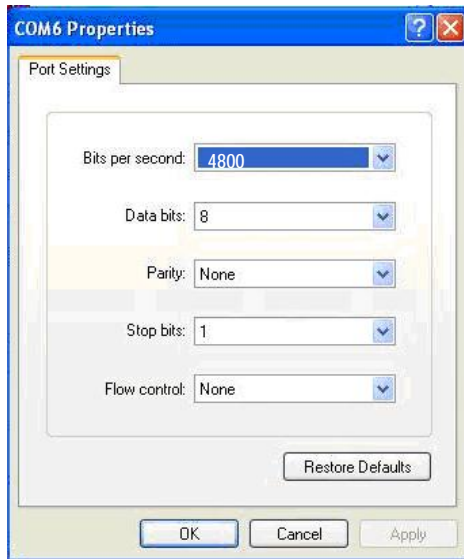

'Settings' General:

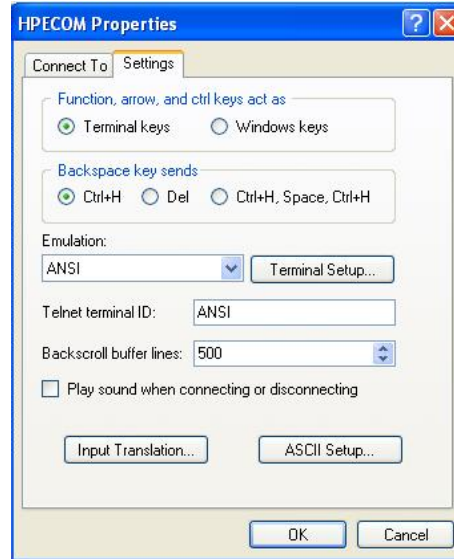

'Settings' ASCII Setup:

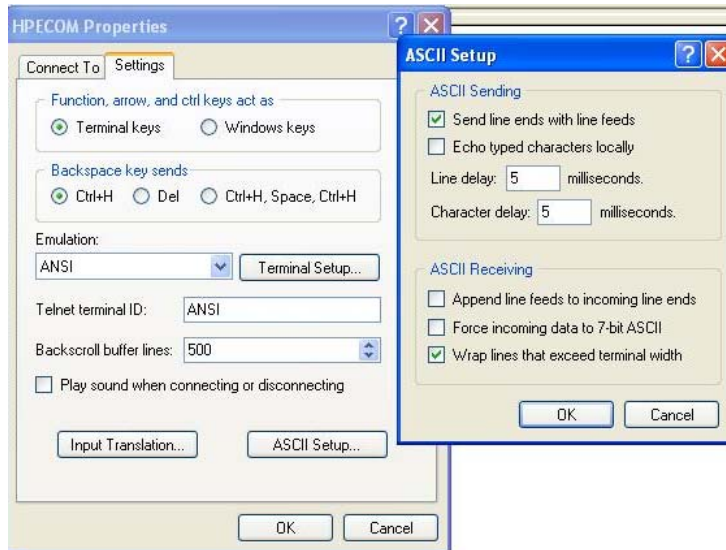



Additional Settings

Some PC platforms may need keyboard response adjustment for initial Terminal Mode success. These settings may be done via the PC Control Panel >> Keyboard Settings:

- Fastest Repeat rate
- Shortest Delay time
- Fastest Cursor Blink rate

Connecting at 76800 Baud Rate

Because HyperTerminal does not support 76800 baud then after setting to 76800 the device baud rate will remain at 9600 baud for HyperTerminal communication and switch to 76800 after Writing the new baud rate and eXiting terminal mode.

To allow later terminal communication a device set with 76800 baud will operate at 9600 baud for the first 5 seconds after a power-up. If no attempt to connect the terminal at 9600 baud is made within 5 seconds of a power-up then the device will automatically switch to 76800 for normal network operation.

Saving HyperTerminal Settings

For ease of connection it is recommended to save the HyperTerminal setup for each baud rate you may wish to use with an easily recognised configuration name. For example:

- HPECOM 24 (2400)
- HPECOM 48 (4800)
- HPECOM 96 (9600)
- HPECOM 19.2 (19200)
- HPECOM 38.4 (38400)
- HPECOM 57.6 (57600)

Changing Baud Rate

After changing to a new baud rate the controller will not start running at the new baud rate until the change has been Written (W). If setting a new baud rate via text file application download the new baud rate will be applied immediately the download is completed (auto-Write).

In either case, after the Write action, you will need to reconnect the terminal program at the new baud rate if you wish to continue the terminal session.



Break in to Terminal Mode

When HyperTerminal is running and the HPECOM cable is connected to the powered device the initial terminal screen will be blank. If the device power is reset "Hello" will appear on the screen. If Hello does not appear on the screen after a power reset then it is likely that the HyperTerminal baud rate setting is incorrect.

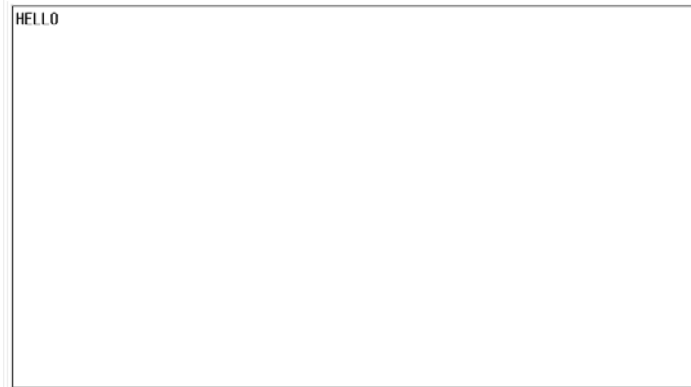

To break in to terminal mode set Caps Lock on and hold the 'T' character key continuously (TTTTTT...). After five (5) T's have been sent to the device it will switch to terminal mode. At this point the device will display the default user screen.



Administration Commands

Function	Enter	Result	Options / Comments
Start communication	TTTTT(TTT...)	Display of configuration and I/O status	<i>With the Caps Lock on, hold the T key down until the screen updates with HPE data. It is not necessary to press the enter key to start communication.</i>
Download textfile	DE	Make ready for file path	Menu: Transfer > Send textfile > file
Upload text file	UE	All settings are uploaded to the terminal for archive or re-use	<i>HyperTerminal: Start a Capture Text procedure before invoking UE then stop the Capture after Upload complete. Indigo you may simply copy the text on the terminal screen to a text file.</i>
Reset to Factory Default	FD=1	Reset to ex-factory settings	<i>FD will be displayed in the top line of the I/O summary screen after reset</i>
Set node address	98=1...32	Network node number is assigned	<i>Example: 98=25</i>
Set baud rate	99=...	Network comms speed is set	2400, 4800 , 9600, 19200, 38400, 57600, 76800 <i>Example: 99=4800</i> After Writing new comm. speed it will be necessary to reconnect with Terminal at the new comm. speed to continue the terminal session!
Zero the Reset counters	95=0, 96=0, 97=0	Each Reset counter is zeroed	<i>Factory diagnostics</i> Resets = <95> <96> <97> <i>Rx timeout, Tx timeout, Hardware reset</i>
Application Number Setting	AN=0...99999	Default Appl. # 162 is changed to user requirement	<i>The application number may need to be customised for older field panels which only accept a fixed selection of application numbers</i>
Write values as default	W	Changes written.	Always do this after making changes that you wish to be permanent
Exit communication	X	Communication with HyperTerminal no longer active	<i>Auto X after 240sec without key entry. After eXit unplug the HPECOM cable to allow network communication to take place</i>

Display Navigation

Function	Enter	Result	Options / Comments
Display Control Commands	A1...8	Display Analogue Logic block	A1, A2, ... A8
	C1...8	Display Control Loop block	C1, C2, ... C8
	D1...8	Display Digital Logic block	D1, D2, ... D8
	M	Display I/O summary screen	M
	P	Display Point status list	Enter P or P1 to display the first 21 Objects. Enter Pxx (where 'xx' is a point #) to display any other point and the following 20 points
	S	Return to User Summary display	S
	SS	Screen Static	Disable 10 sec live update
	SL	Screen Live	Enable 10 sec live update
	SLLD	Screen Line Logic Display	Enable/Disable display of object numbers and screen line numbers in the summary display



Summary Screen Setting

Function	Line	Method	Result	Options / Comments
Summary Display Lines & dynamic point setting	SL1...32	SL(x)x=abc...	Assign Screen Line text as information or in relation to SP1...32	Alpha/numeric, 40 characters max.
	SP1...32	SP(x)x=nnn	Assign Screen Point dynamic point value	Point #
	SLL1...32	SLL(x)x=nnn	Assign Screen Line Logic point who's value >0 will cause the related screen line to appear at the top of the display (alarm state for instance)	Point #

Manual Override / Release

Values that have been manually set will be indicated in HyperTerminal by an **M** tag next to the displayed value.

Manualled physical inputs (points 1...8 & 17...24) will revert to 'Auto' after being Released or after a power reset. Physical outputs will retain the Manual setting after a power reset if the Manual state is Written (**W**) before being released, thereby making the Manual state the power-up default state. If the 'Remember' function is enabled for an output the last commanded state is valid after a power reset.

Function	Enter	Result	Options / Comments
Manual a Digital	Point #=1, 0	Digital on or off	1=On 0=Off <i>Example: 37=1</i>
Manual an Analogue	Point #=0...n	0...100% block output	Block range 0...max <i>Example: 25=50 (AO1 50% output / 5Vdc output)</i>
Release Manual overrides back to 'Auto' *	R R=1...92	Inputs will return to auto state/value. Other points will remain at manualled state/value until power reset or commanded	<i>Example 1: R All overrides are cleared</i> <i>Example 2: R=9 DOI (point 9) only return to Auto</i>
Reset pulse accumulator	1700...2200=6	DI or UI with pulse accumulator config. (UI or DI setting 6) is reset to zero	<i>Example: 1800=6</i>



Operational Displays

User Summary Screen

After breaking in to terminal mode the user defined point summary screen appears. This screen may be programmed by the user to provide a dynamic listing of point values specific to the application running in the device. Below is the factory default summary screen.

```
Point Summary
DI 1          OFF  D
UI 1          92.0 Ctc
DO 1          OFF  D
AO 1          0.0  %

Data above as example
All lines configurable
```

By entering **SLLD** (Screen Line Logic Display) the text line numbers, the point numbers relating to the dynamic points assigned to each line and any SLL (Screen Line Logic) links are displayed.

```
1 Point Summary
2
3 DI 1          1  OFF  D
4 UI 1          17 92.0 Ctc
5 DO 1          9  OFF  D
6 AO 1          25 0.0  %
7
8 Data above as example
9
10 All lines configurable
11
12 POINT 1 HIGH DISPLAYS ME AT THE TOP  SLL 1  OFF  D
13
14
15
16
17
18
19
20
21
22
23
24
```

On line 12 you can see a text entry that will not be seen when SLLD is off but will appear at the top of the screen when the point set for SLL12 is high, in this case point 1 (Digital Input 1). Enter SLLD again to revert to normal display mode. Below is the appearance of this hidden line when SLLD is off and DI1 is high.

```
POINT 1 HIGH DISPLAYS ME AT THE TOP
Point Summary
DI 1          ON M D
UI 1          92.0 Ctc
DO 1          OFF  D
AO 1          0.0  %

Data above as example
All lines configurable
```

You may use SLL settings for alarm or warning text that will only appear when the assigned point has a value >0.



Download Text File

Enter DE (Download Eprom) and you will see 'Ready' bottom-left of the screen. Now go to the Transfer menu item in HyperTerminal, select Send Text File, then open the path to the text file, created in the FuncProg tool, which you want to download.

The 'Ready' state is active for 20 seconds. If the text file location on your PC has a long path to find it the 'Ready' state may time out. It is recommend that you save the application text files in a folder on your PC Desktop to locate them in a time efficient manner.

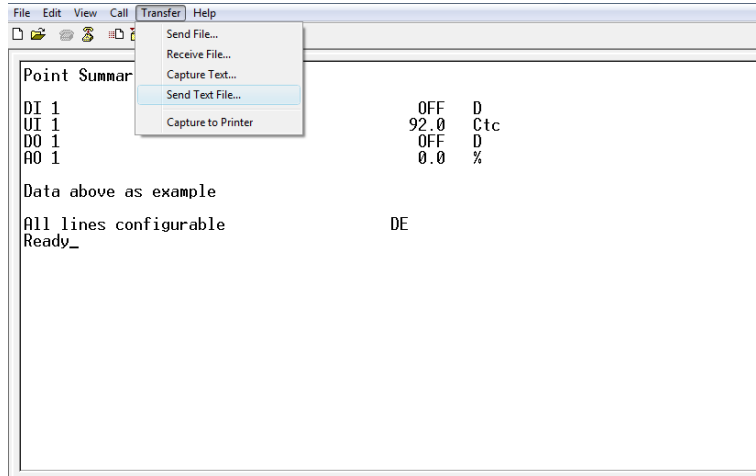

After the text file has downloaded you will briefly see a check of the number of lines expected versus the number of lines received. If the two values are equal 'Restarting...' will be displayed at which point the new configuration is written to non-volatile memory automatically.

Below is the user summary screen after download of a configuration for room temperature/supply air temperature cascade with 100k NTC sensors on UI's 1 & 3 (points 17 & 18), 3-point floating cooling valve (DO1 & DO2 – points 9 & 10) and electric heating (PWM, DO3, point 11)

1	Room/Supply Air Cascade			
2				
3	BMS Enable	29	OFF	D
4	Occupancy Switch	1	OFF	D
5				
6	Room Temperature	17	21.1	M Ctc
7	Room Temperature Setpoint	45	22.1	Ctc
8	Cooling Setpoint (Read Only)	61	23.1	Ctc
9	Heating Setpoint (Read Only)	63	21.1	Ctc
10				
11	Supply Air Temperature	18	15.1	M Ctc
12	SA Cooling Limitation	46	12.0	Ctc
13	SA Cooling Setpoint (Read Only)	62	22.0	Ctc
14	SA Cooling Demand	70	50.0	%
15	Cooling Valve Open Command	9	0.0	%
16	Cooling Valve Close Command	10	0.0	%
17				
18	SA Heating Limitation	47	35.0	Ctc
19	SA Heating Setpoint (Read Only)	64	22.0	Ctc
20	SA Heating Demand	72	0.0	%
21	Heating PWM	11	0.0	%
22				
23				
24	HRW Limited - Ph +852 2546 7402			

- Column 1 = Screen Line number (enter SLLD to toggle this column display on or off)
- Column 2 = User point description or general information text
- Column 3 = Point number of the displayed dynamic value (enter SLLD to toggle on or off)
- Column 4 = The dynamic point value
- Column 5 = Units related to the dynamic point value (as configured in the linearization table)



Main' Physical I/O Display

By entering **M** (Main) we can view the physical I/O summary status in the next illustration. In this example points 9 & 10 (DO1 & DO2) have Max. Run time of 1000 seconds set to reduce wear & tear of the 3-point actuator when open or closed command is at 100%; after 1000 seconds the output will electrically be switched off (logically still seen as ON) until the command value falls below 100% at which time the Max Run timer will reset. In practice it is recommended to set the Max Run timer at 2 x the actuator running time.

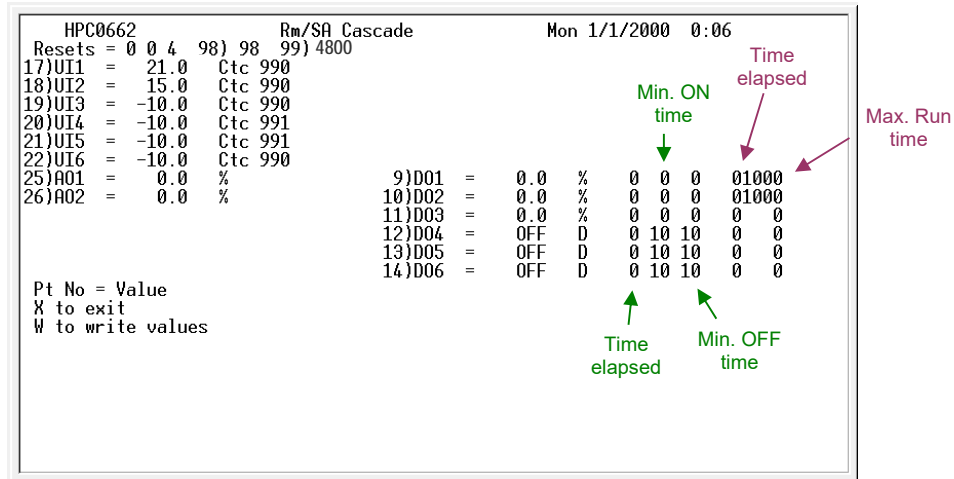

UI's display the linearized & scaled value (including calibration offset if any), the units as set in the linearization table and, to the right of the units, the 'raw count' as seen by the microprocessor prior to linearization and scaling being applied.

Point List Display

Enter **P** to display the first 21 active points. The listing will include any active logic connections and, in the case of the UI's the present calibration offset if used.

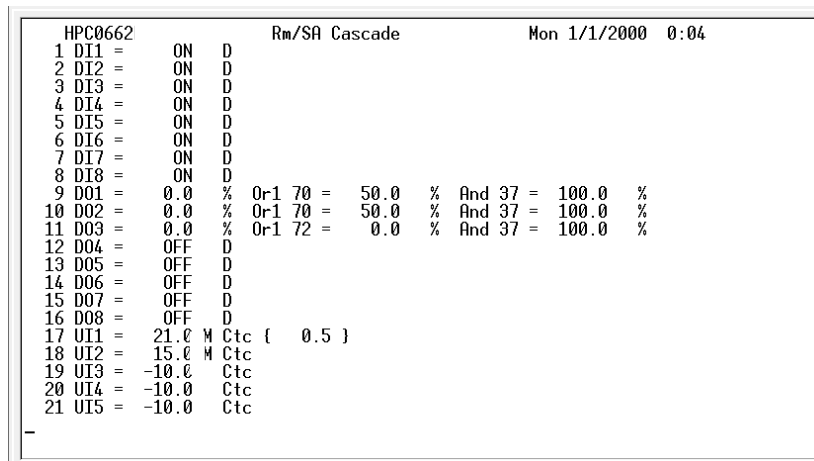



Enter P22 or any other starting point # to display another set of 21 device relevant sequential points.

```
HPC0662          Rm/SA Cascade          Mon 1/1/2000  0:05
22 UI6 = -10.0 Ctc
23 UI7 = -10.0 Ctc F1
24 UI8 = -10.0 Ctc
25 A01 =  0.0 %
26 A02 =  0.0 %
27 A03 =  0.0 %
28 A04 =  0.0 %
29 VDI1 = OFF D
30 VDI2 = OFF D
31 VDI3 = OFF D
32 VDI4 = OFF D
33 VDI5 = OFF D
34 VDI6 = OFF D
35 VDI7 = OFF D
36 VDI8 = OFF D
37 DL1 = ON D
38 DL2 = OFF D
39 DL3 = OFF D
40 DL4 = OFF D
41 DL5 = OFF D
42 DL6 = OFF D
```

Control Loop (CL) Display

To display the Control Loop statuses enter **C1** for loop 1, **C2** for loop 2, etc. Below we see the display of CL2 (point 70) which shows the relevant input connections/statuses and output values, including the connected physical outputs, for the supply air cooling control.

```
HPC0662          Rm/SA Cascade          Mon 1/1/2000  0:20
Loop(70)
StartPt(37) OFF      Output 50.0 %      ErrorInt  0
Input 18  15.0 M Ctc  Action2 DIR50 PBand(78) 10.0 Ctc Int(86) 180 Sec
SetPt(62) 22.0 Ctc  SPDeadBand  0.0 Ctc SPMax  92.0 Ctc SPMIn -10.0 Ctc
AND 38  0.0 %
Value      OR      AND      Prop      On      Off
10)DO  0.0 % ( 0)      (37) 0.0 %  10      0      48
9)DO  0.0 % ( 0)      (37) 0.0 %  10     100     52
```

The control loop is set as DIR50 which means the loop output is 50% at set point. In this case the DIR50 control reaction is used for driving a 3-point actuator, cooling application, with the associated DO's set for 10sec PWM cycle, DO1 (point 9) operating as open command when the loop output is above 50% and DO2 (point 10) operating as the close command when the loop output is below 50%. Point 37, a Digital Logic block 1, is set as the start signal for the control loop and as the enabling point for the DO's (DO sub-parameter #02 – AND).



Digital Logic (DL) & Analogue Logic (AL) Display

The Digital Logic and Analogue Logic block statuses may be displayed by entering D1, D2... D8 or A1, A2... A8 respectively. Below is the display of the active Digital Logic blocks of the subject application:

- DL1, Point 37 – OR function for BMS or Local enable; either VDI1 (point 29) or DI1 (point 1) being high will result in point 37 being high
- DL2, Point 38 – OR function for release of SA cooling when the room cooling loop (point 69) has demand present
- DL3, Point 39 – OR function for release of SA heating when the room heating loop (point 71) has demand present

```
HPC0662P1V4.01App162 Rm/SA Cascade
Digital Logic(37) Output OFF D
OR DelayOn 0 DelayOff 0 Timer 0
Inputs In 29 OFF D In 1 OFF D In 0 In 0

Digital Logic(38) Output OFF D
OR DelayOn 0 DelayOff 0 Timer 0
Inputs In 69 0.0 % In 0 In 0 In 0

Digital Logic(39) Output OFF D
OR DelayOn 0 DelayOff 0 Timer 0
Inputs In 71 0.0 % In 0 In 0 In 0
```

- AL1, Point 53 – Proportion (shift) function; CL1 output (point 69, room cooling demand) proportionally shifts the supply air cooling set point from 22°C down to 12°C
- AL2, Point 54 – Proportion (shift) function; CL3 output (point 71, room heating demand) proportionally shifts the supply air heating set point from 22°C up to 35°C

```
HPC0662P1V4.01App162 Rm/SA Cascade
Analog Logic(53) Output 22.0 Ctc
Prop Offset 0.0 Ctc VIn1 -10.0 VOut1 -10.0 VIn2 90.0 VOut2 90.0
Inputs In 69 0.0 % In 45 22.0 Ctc In 46 12.0 Ctc In 0

Analog Logic(54) Output 22.0 Ctc
Prop Offset 0.0 Ctc VIn1 -10.0 VOut1 -10.0 VIn2 90.0 VOut2 90.0
Inputs In 71 0.0 % In 45 22.0 Ctc In 47 35.0 Ctc In 0
```



Reset to Factory Default

If using a device that has previously been programmed it is recommended to reset the device to Factory Default before reprogramming to ensure any old settings that are unwanted in the new program do not have any influence on the new application.

To perform a Factory Default reset enter **FD=1**

A device set at Factory Default settings will have 'FD' displayed in the top line of the Main physical point summary screen [M]).

Note: If using devices with firmware less than version 4.00 then you must download the Factory Default text file to reset the device to Factory Default.

Upload Text File

In event that application files are lost it is possible to retrieve an application settings Text File from a device using the UE (Upload Eeprom) command.

After entering UE the current settings in the device will be printed on to the terminal screen. With HyperTerminal it is possible to Capture this upload:

- 1) Start a Capture Text from the Transfer menu of HyperTerminal
- 2) Enter UE
- 3) After the print of all settings has completed then stop the Capture
- 4) Locate the text file which was created during the Capture process
- 5) Clean up the file by deleting any lines that are not relevant setting lines
- 6) Count the number of lines (paste in to Excel cell A1 is a fast way to check the line count)
- 7) Add one more line at the bottom of the file with content 10000=nnn
 - a. nnn value is the number of lines previously counted + 1
 - b. Ensure there is one line return after the 10000=nnn line

This text file is now ready for saving as a backup or for Down Load to other devices.

Other terminal programs may have other processes for saving the uploaded text. In some cases it may simply be a case of copying the relevant lines of the screen and pasting in to Notepad. Whatever the process, the 10000=nnn line must be added if the file is to be used for Down Load in future.

Universal Inputs

UI resistor rafts are configured as **10k NTC or DI by default** with each raft accommodating two inputs. By reconfiguration of the resistor rafts it is possible to use 100k NTC, 0-10Vdc or 4...20mA sensors.

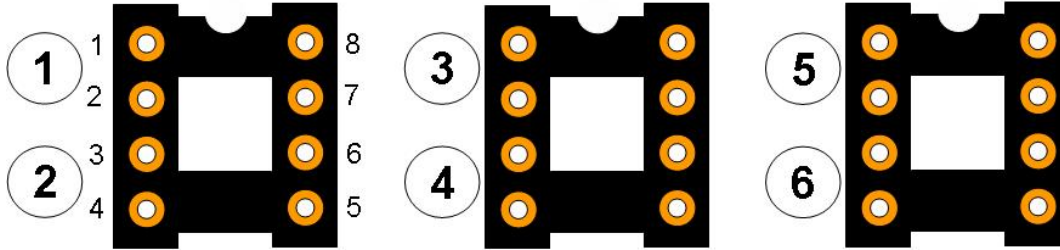

UI raft configurations are made according to the table below and by PC assignment of the relevant Sensor Type. **Factory default input raft configuration is 10k NTC or DI by default.**

When making own raft configurations select ¼ Watt resistors of 1% tolerance or better.

Sensor Type	Inputs 1, 3 & 5	Inputs 2, 4 & 6	Resistance
10k NTC / DI	Link 1 to 8	Link 3 to 6	10kΩ
100k NTC / DI	Link 1 to 8	Link 3 to 6	100kΩ
0-10Vdc	Link 2 to 7	Link 4 to 5	100kΩ
4...20mA	Link 1 to 2	Link 3 to 4	250Ω



Linearisation Table

The Linearisation Table provides conversion of the UI physical signal in to an engineering value for display and control in other areas of an application. Sensor Types 0...5 may be customised to suit different scaling for a specific active sensor type or to suit a passive sensor element that is not already pre-programmed as a factory default.

Factory Default Sensor Types

UI Sensor Type	Sensor	Units Tag	Scale
0	100k NTC (B25/50: 4200) 10k NTC type 2 (B25/50: 3935)	Ctc	-10...90 °C
2	0-10Vdc	%V1	0...100%
3	4...20mA	%mA	0...100%
5	10k NTC type 3 (B25/50: 3630)	Ctx	-10...90 °C

Enter <L> to display the default linearization table.

1		C	C	%	%	C	C	Units character1
2		t	n	V	m	p	t	Units character2
3		i	n	1	A	t	x	Units character3
4	0	852	243	0	200	173	819	
5	150	723	319	150	320	306	695	
6	300	554	393	300	440	436	546	
7	450	385	465	450	560	555	399	
8	600	249	535	600	680	669	277	
9	750	154	604	750	800	777	188	
10	900	95	671	900	920	879	124	
11	1024	59	723	1007	1007	950	89	
12		-100	-100	0	0	-100	-100	Intercept
13		-1	-1	-1	-1	-1	-1	Decimal shift (-2...2)
14		1	1	1	1	1	1	Multiplier (1...9)

Column 1 (Reference)
 Column 2 (UI Sensor Type 0)
 Column 3
 Column 4
 Column 5
 Column 6
 Column 7 (UI Sensor Type 5)

Active Sensor Scalings

Column 1 is the fixed reference to which all display results are based. The range of the reference column 1 is effectively 0...1000.

It is important to interpret the reference values in combination with the intercept and scaling data at rows 12...14. Taking Sensor Type 2, 0-10Vdc, as an example:

- The microprocessor raw count range of 0...1000 relating to 0-10Vdc results in 0...100% display because the reference column values are being decimal shifted one place to the left (row 13 column 4 = -1)
- If 0-10Vdc is to be displayed directly as 0-10Vdc then we need to decimal shift -2 at row 13 column 4 and change Units display characters
 - 134=-2
 - 14=V (row 1 column 4)
 - 24=d (row 2 column 4)
 - 34=c (row 3 column 4)



- If 0-10Vdc is to be displayed as 0...50°C then decimal shift the display reference range -2 at row 13 column 4, multiply it by 5 at row 14 column 4 and change units characters (remove surplus characters by entering a <space>)
134=-2
144=5
14=C (row 1 column 4)
24=<space> (row 2 column 4)
34=<space> (row 3 column 4)
- If a second 0-10Vdc sensor with different scaling is needed, say, 0...2000 PPM, then copy default 0-10Vdc raw count data to a column who's existing sensor data will not be used in future. The following settings assume overwrite of the Ni1000 column 3 (Sensor Type 1)
13=P
23=P
33=M
43=0
53=150
63=300
73=450
83=600
93=750
103=900
113=1007
123=0
133=0
143=2

In the last example the display reference column range is unchanged, 0...1000, until the multiplier at row 14 is applied (x2) resulting in a final scale for PPM of 0...2000.

Note: The value at the intercept row, 12, will have the decimal shift (row 13) and multiplier (row 14) applied to it. Therefore, if intercept -10.0 is required and decimal shift will be -1 (x0.1) then enter -100 in row 12 as the final result after processing with the decimal shift will be an intercept of -10.0

Using the FUNCProg tool these settings can be generated in table form for saving as a download text file.

Passive Sensor Definition

Non factory default passive sensors with thermistor element of 10kΩ or greater may be configured

1. Set up a UI raft with suitable resistance links fitted and plug it in to the raft socket of the UI being used. If the sensor was 20kΩ at 25°C then 20kΩ would be fitted in link 2 of the UI raft
2. Consult the manufacturers resistance chart for the sensor being used and connect resistance equivalent to the reference values in Column 1 (note that in the reference column 1 the reference value 150 is considered as 15°C once the decimal shift of -1 is applied at row 13)
3. Assign an otherwise unused Sensor Type to the test UI
4. In the Main I/O display read and record the raw count value, as displayed to the right of the units for the UI to which the test resistance is connected
5. Enter the raw count in the table at the corresponding reference value row and column;
<row#><column#>=<raw count>
6. Complete the raw count entry for all reference points
7. If an intercept other than zero (0) is applied then raw count measurements must be at reference values shifted an equivalent amount

Reset to Factory Default

The **FD=1** reset command also resets changes to the linearization tables



Installation & Commissioning

- This is an RS485 network device designed for indoor use, mounted in a dry electrical panel. Ideally it should be mounted to the panel backplane in a horizontal position (inputs on the lower side and outputs on the upper side)
- Each 24Vac power supply transformer must have the neutral (24Vac N) connection grounded at the electrical panel earth connection to ensure the device grounding is at the same potential as the network master's grounding
- Where more than one device is connected to a common transformer ensure that the 24Vac phasing is the same to each device ('A' connects to 'A', 'N' connects to 'N' in all cases)
- If the red comms light adjacent to the RS485 terminals emits an obvious flash every time 24Vac power is applied to the device then the micro-processor may be corrupted. The micro processor should be replaced
- Twisted pair shielded cable must be used for the sensors and transmitters connected to the universal inputs (UI's). The sensor cable shield must be grounded, at the device end only
- RS485 multi-drop cable should be used for the network connections, complete with end of line terminating resistors (120Ω). Belden 9841 or equivalent is recommended. The recommended cable is a low capacitance twisted pair with braid and foil screen
- The RS485 cables should be terminated directly at each device in a daisy-chain configuration, avoiding 'laterals' or 'spurs'
- The RS485 screen should be connected at the network master's ground terminal. The incoming and outgoing screen at each device should be continuously connected via the S terminal of the device (note that the device's S terminal has no electrical connection to the device, it merely acts as a junction terminal for the purpose of screen continuity)
- The RS485 cable should avoid cable routes that run with power cables. Where the RS485 cable must cross power cables then they should cross at 90° avoiding parallel runs beside power cables
- Prior to connection of the slave devices to the RS485 network check that no AC voltage is present. Double check the network for short circuits between the twisted pair cores and between the cores and the screen. Ensure continuity of the twisted pair cores and the screen
- Check the network master's +/- terminals for correct voltages to ground (approx. 2.5Vdc) and connect the RS485 network cable to the network master's RS485 port
- At each device assign an individual address and the baud rate specific to the network. Write the changes, eXit the terminal application and remove the HPECOM cable
- Verify network voltage at the RS485 connector (between +/- and ground) and connect to the device. Communication can be verified by flashing of the red comms LED adjacent the 3 terminal RS485 connector). Frequency of comms LED flash is baud rate dependant. At higher baud rates the LED flash may not be obvious, the LED appearing to be continuously on
- Where a network runs between buildings and zero earth potential difference between individual panel 24Vac power supplies cannot be guaranteed, we recommend that a repeater be used to provide isolation of the sections of the network having differing earth potential

Connections

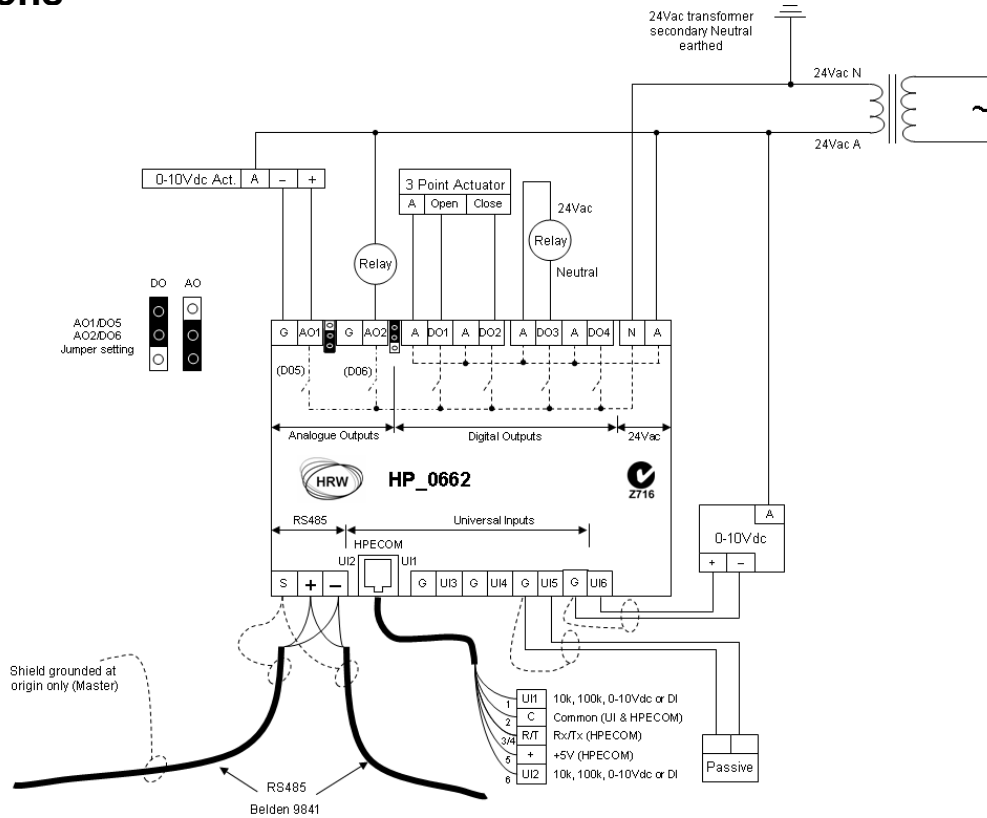

Dimensions

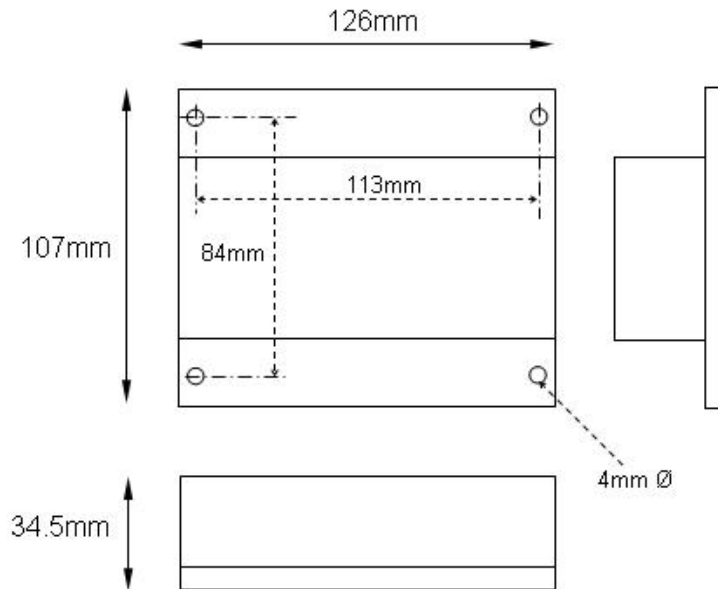

If using HDA0002 DIN rail adapter brackets the overall depth from the gear plate to the front surface of the device is 45.5mm



Technical Data

Inputs/Outputs	
6 UI	- Digital Input (DI) - NTC thermistor 10k Ω (default), 20k Ω , 100k Ω - 0-5Vdc, 0-10Vdc, 0-20Vdc, 0.01 Volt resolution - 0...20mA, 4...20mA, 0.016mA resolution (requires external 18...28Vdc loop power supply)
4 DO	- 24Vac, 3A in-rush, 300mA holding max., minimum load 10mA
2 UO (jumper selected)	DO - 24Vac, 3A in-rush, 300mA holding max., minimum load 10mA AO - 0-10Vdc, 0.04 Volt resolution, 1.5mA (min 6.6k Ω impedance)
Sensor/Transmitter Wiring	Shielded twisted pair (shield grounded)
Network Wiring	Belden 9841 low capacitance twisted pair for RS485 networks (braided + foil shield, shield continuous throughout the network and grounded at network origin)
Comms Speed	RS485 - 2400, 4800, 9600, 19200, 38400, 57600, 76800 baud
RS485 Driver	Isolated 1/8 th load, 256 nodes over max. 1.2km without repeater
Power Supply	24Vac, 50/60 Hz, max. 5VA without DO load 50VA MAX. when DO's supplied via the device's 24Vac terminals and fully loaded @ max. 300mA / DO
Conformity	Energy Management Equipment / UL916:2015 Edition 5 Signal Equipment / CSA C22.2#205:2017 Edition 3
Approvals	FCC Part 15 Subpart B Class B CE/EMC EN 55022, EN 55024, EN 61000-3-2, EN 61000-3-3
Operating Temperature Range	0...50°C (32...122°F)
Storage Temperature Range	-5...75°C (-40...167°F)
Humidity Range	10...95%rH (non-condensing)
Dimensions	107mm H x 126mm L x 34.5mm D



Ordering Information

HPC0662P1

Description: Universal Controller, 28 Point, P1 FLN, 24Vac
Standard package: 40 units per carton

Accessories

HDA0002	DIN rail adapter brackets, factory fitted
HSD0011	10k NTC Room temperature sensor, c/w discrete occupancy button (press sensor face), RJ11 connected to UI1 & UI2
HSD0012	10k NTC Room temperature sensor, c/w set point dial and discrete occupancy button (press set point dial), RJ11 connected to UI1 & UI2
HPU2-RA010	UI1/UI2, UI3/UI4 or UI5/UI6 raft, Active 0-10Vdc, pack of 50
HPU2-RA420	UI1/UI2, UI3/UI4 or UI5/UI6 raft, Active 4...20mA, pack of 50
HPU2-RC1090	UI1/UI2, UI3/UI4 or UI5/UI6 raft, NTC100k -10...90°C, pack of 50 (factory default rafts are 10k NTC / digital)
HPR6	Relays module, 6 x Opto-iso SPDT 250Vac 10(7)A n/o 6A n/c, ac/dc trigger, Auto/Off/Manual switch, 24Vac
FUNCPROG	Application creation tool
HPECOMU	Configuration cable (USB <> RJ11)

Other HP_P1 Series Devices

HPC8884P1	Universal Controller, 28 Point, P1 FLN, 24Vac
HPC8884BP	Universal Controller, 28 Point, P1 FLN switchable BACnet MSTP, 24Vac
HPD0460P1	Network HMI, 12 Point, P1 FLN, 24Vac
HPD0460P1C	Network HMI / Universal Controller, 10 Point, P1 FLN, 24Vac
HPD0460P1CT	Network HMI / Universal Ctrl / Scheduler, 10 Point, P1 FLN, 24Vac
HPD0460P1T	Network HMI / Scheduler, 10 Point, P1 FLN, 24Vac
HPE8884P1	I/O expansion, 28 Point, P1 FLN, 24Vac
HPV0662P1	VAV / Universal Controller, 13 Point, P1 FLN, 24Vac
HPE-P1MBUS	P1 FLN gateway for M-Bus devices, 96 point, 24Vac
HPE-P1MBUS-195	P1 FLN gateway for M-Bus devices, 195 point, 24Vac
HPE-P1MOD2	P1 FLN gateway for Modbus devices, 96 point, 24Vac
HPE-P1MOD2-195	P1 FLN gateway for Modbus devices, 195 point, 24Vac



Document Update History

- | | |
|---------------------|--|
| V4.02 220727 | Added HPC8884BP to 'Other Devices' list |
| V4.02 200714 | Industry conformance update, image update (plug-in terminals) |
| V4.02 150622 | HRW address updated |
| V4.02 141030 | Minutes Run, Compare functions, upload application text-file, download network settings in text-file, isolated RS485 |