

TLC3-FCR-2 Intelligent Fan Coil controller

Features

- The PWM and 3-point floating control option reduces room temperature fluctuations and energy consumption
- Low power energy consumption: < 1W per unit
- Temperature control for 2- and 4-pipe fan coil systems.
- Automatic fan control for three stage fans.
- Cost saving option with Economy functionality and set point limitations
- Control for single stage heating, cooling and fan only operation modes
- Password protected programmable user and control parameters
 - Setpoint range limitation
 - Access control for setpoints, fan speeds and mode change
 - Access control for heat/cool change and time programs
 - Select your display contents
 - Selectable behavior after return from power failure
- Temperature display in Celsius or Fahrenheit

Deluxe Version:

- Clock and time schedule functions with power failure protection
- Blue backlight for LCD
- Infrared remote controller option:
With special features for Boost and delayed switching on or off



Applications

- Air Only Systems:
 - Constant Air Volume systems with three stage fans for single or dual duct systems
- Air/Water Systems:
 - Fan Coil units for 2-pipe or 4-pipe systems
 - radiator control, chilled ceiling
- Simple individual room control for hotel rooms, meeting rooms, etc.
- PWM or On-Off-Control of 2 spring return valves or 3-point on-off or floating control of one 3-point valve.

General Description

The TLC3-FCR-2 is a stand-alone electronic fan coil controller with one control loop. The TLC3-FCR-2 features 1 NTC temperature sensor input and five binary outputs (Relays).

A detailed parameterization is possible with the use of a simple configuration routine. The TLC3-FCR-2 can be configured using the standard operation terminal. No special tools or software is required.

Ordering

Item Name	Item code	Variant	Power	Features
TLC3-FCR-2-24 TLC3-FCR-2-24-W01	40-10 0130 40-10 0130-01	Standard Cooling only	24VAC/DC	Fan coil controller with: 1 TI int 3 DO (Relay) Fan control 2 DO (Relay) Binary valve control
TLC3-FCR-2-230 TLC3-FCR-2-230-W01	40-10 0118 40-10 0118-01	Standard Cooling only	230VAC	
TLC3-FCR-2-D-24 TLC3-FCR-2-D-24-W01	40-10 0135 40-10 0135-01	Deluxe Cooling only	24VAC/DC	
TLC3-FCR-2-D-230 TLC3-FCR-2-D-230-W01	40-10 0119 40-10 0119-01	Deluxe Cooling only	230VAC	

Selection of valve actuators and fans

Binary auxiliary devices: E.g. fans and on/off valves. Do not directly connect fans that exceed 2A and actuators that exceed 0.3A. Observe startup current on inductive loads! Do not connect more than one fan coil unit to one controller.

Technical Specification

Power Supply	Operating Voltage	-24	-230
	AC voltage: 50/60Hz	22-26V AC/DC	210–250 VAC
	Power Consumption	Max 1W, 1.5 VA	
	Electrical Connection	Terminal Connectors	
	Deluxe type only: Power backup for real time clock	Min 48h if charged for 24h	
Signal Inputs	Temperature Inputs Range Accuracy	RT Internal, External (Sxx-Tn10 sensor) 0...50 °C (32...122 °F) 0.5°C (1°F)	
Signal Outputs	Digital Switching Outputs Switching Type AC Switching power	DO1 to DO3 Relays 250V AC 2A max. each output	
	Digital Switching Outputs Switching Type AC Switching power	DO4...DO5, TRIAC TRIAC 250V AC 0.3A max. each output	
	Insulation strength between contacts and system electronics: between neighboring contacts	3750V AC to EN 60 730-1 1250V AC to EN 60 730-1	
Environment	Operation Climatic Conditions Temperature Humidity	To IEC 721-3-3 class 3 K5 0°C ...50°C (32°F...122°F) <95% R.H. non-condensing	
	Transport & Storage Climatic Conditions Temperature Humidity Mechanical Conditions	To IEC 721-3-2 and IEC 721-3-1 class 3 K3 and class 1 K3 -25°C...70°C (-13°F...158°F) <95% R.H. non-condensing class 2M2	
Standards	 conformity EMC Directive Low Voltage Directive	2004/108/EC 2006/95/EC	
	Product standards Automatic electrical controls for household and similar use Special requirement on temperature dependent controls	EN 60 730 –1 EN 60 730 – 2 - 9	
	Electromagnetic compatibility for domestic sector	Emissions: EN 60 730-1 Immunity: EN 60 730-1	
	Degree of Protection	IP30 to EN 60 529	
	Pollution Class	II (EN 60 730-1)	
	Safety Class: for -24 types for -230 types	III (IEC 60 536) II (IEC 60 536)	
	Overvoltage Category: for -24 types for -230 types	I (EN 60 730-1) III (EN 60 730-1)	
General	Dimensions (H x W x D)	Front part: 21 x 88 x 88mm (0.8 x 3.5 x 3.5 in.) Power case: 60 x 50 x 32mm (2.4 x 2.0 x 1.3 in)	
	Material: Cover, back part Mounting Plate	Fire proof ABS plastic (UL94 class V-0) Galvanized Steel	
	Weight (including package) for -24 types for -120 and -230 types	standard: 255g (9.0oz), deluxe: 265g (9.3oz) standard: 295g (10.5oz), deluxe: 305g (10.8oz)	

Dimensions

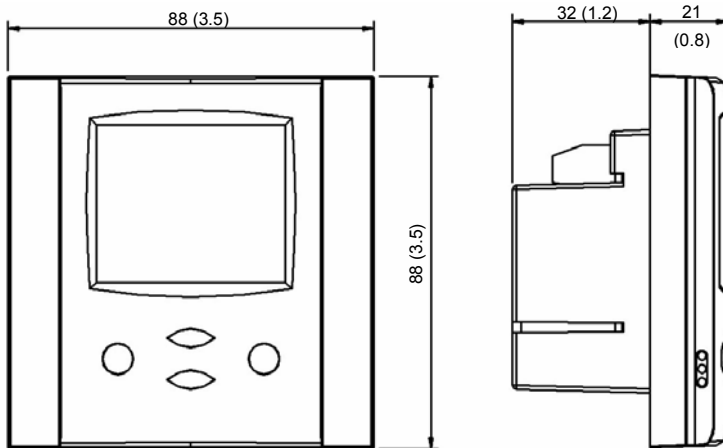

Space required in flush mounting box:
(H x W x D)
60 x 50 x 32mm (2.4 x 2.0 x 1.26 in.)

Distance for mounting screws:
Horizontal and vertical:
45 to 63mm (1.8 to 2.5 in.)

Mounting location

- Install the controller on an easy accessible interior wall, approx. 1.5 m above the floor in an area of average temperature.
- Avoid direct sunlight or other heat sources, e.g. the area above radiators and heat emitting equipment.
- Avoid locations behind doors, outside walls and below or above air discharge grills and diffusers.
- Location of mounting is less critical if external temperature sensors are used.

Installation

1. Connect the wires to be connected to the terminals of the power case according to wiring diagram
2. Install the mounting plate to the flush mounting box. Make sure that the nipple with the front holding screw is facing to the ground. Make sure the mounting screw heads do not stand out more than 5 mm (0.2") off the surface of the mounting plate.
3. Ensure that the jumpers are set correctly.
4. Slide the two latches located on the top of the front part into the hooks at the upper side of the mounting plate.
5. Carefully lower the front part until the interconnector reaches the mounting-plate. Continue pressing in a gentle way until the front part is fully connected. While inserting the connectors, a slight resistance can be felt. This is normal. Do not use excessive force!
6. With a Phillips-type screw driver of size #2, carefully tighten the front holding screw to secure the front part to the mounting plate. This screw is located on the front lower side of the unit. There is no need to tighten the screw too much.

Wiring Diagram

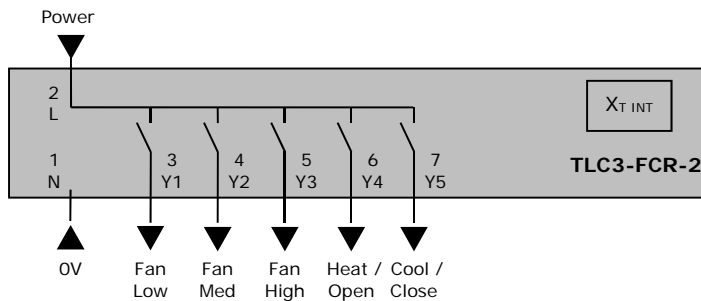





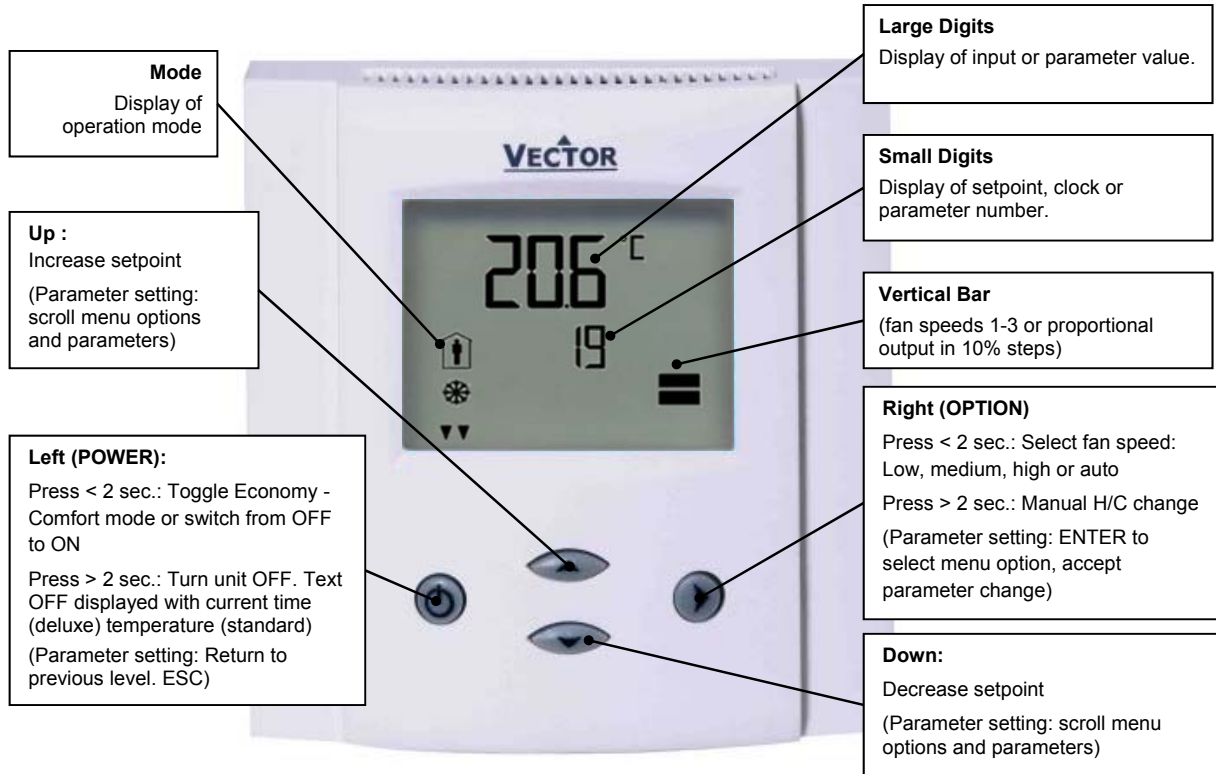

Description:

N	Power supply:	0V Neutral
L	Power supply:	-24: 24VAC/DC, -120: 120VAC, -230: 230VAC
Y1	Binary output:	Fan speed low
Y2	Binary output:	Fan speed medium
Y3	Binary output:	Fan speed high
Y4	Binary output:	Heating Valve or OPEN if in 3-point floating mode
Y5	Binary output:	Cooling Valve or CLOSE if in 3-point floating mode

Display and Operation



Operation mode

	Comfort (occupied)	All control functions operating per set points.
	Economy (unoccupied):	Set points shifted according to <i>Parameters FC04</i> . Economy mode and setpoint shift may be disabled with UP06
OFF	Energy Hold Off	Outputs are off, inputs monitored for alarm condition
	Heating	Output activates if temperature lower than setpoint
	Cooling	Output activates if temperature higher than setpoint
	Fan	Fan is running, the vertical bars show active speed 1-3
	Manual mode	Manual override of fan speed, fan only mode or override of time schedule active.
	Schedule	Deluxe only: Time schedule is active

Power Failure

All the parameters and set points are memorized and do not need to be reentered. Depending on **UP05** the unit will remain switched off, switch on automatically or return to the operation mode it was in before the power failure.

Deluxe version only: Timer operation and daytime setting will be retained for 24h. The controller has to be connected to a power supply for at least 10 hours for the backup function to operate accordingly.

Frost Protection

The controller will enter frost protection mode if the room temperature drops below 5°C (41°F). All heating outputs will be fully opened. Frost protection mode will be left once the temperature reaches 10°C (50°F). Frost protection display will remain until a button is pressed. Frost protection can be enabled/disabled using user parameter UP-09

Error messages

Following error condition may be shown:



Err1: Error temperature sensor. The internal temperature sensor may be damaged or not present.

FP: Steady: Frost protection is active.

Blinking: Frost protection activated in the past and is now inactive. Confirm with OPTION key.

Manual heat – cool change

To manually change heating or cooling mode press the OPTION key for more than 2 seconds. Access to manual heat – cool change may be disabled by parameters.

For standard models: Press OPTION > 2 sec. SEL and H-C is displayed. For deluxe models: Press OPTION > 2 sec. SEL and current time is displayed. Press UP key twice. SEL and H-C is displayed. Press OPTION again to toggle Heating, Cooling and Fan only modes.	SEL H-C   
---	---

Clock operation

The deluxe model contains a quartz clock with battery back-up. Up to 4 time schedules with each 4 mode changes based on time and day of the week may be programmed. A blinking clock indicates that the time has not been set or if the unit was without power for longer than 48 hours. The time needs to be set to allow time schedules to operate.

Clock setup

Press OPTION > 2 sec. SEL and current time displayed Press OPTION < 2 sec. to change time, Minutes blink: UP/DOWN to changes, OPTION to save, Hours blink: UP/DOWN to changes, OPTION to save, Press OPTION to save time, DAY1 blinks: UP/DOWN to change, OPTION to save	SEL 00:00 DAY1 (Mon)
---	----------------------------

Creating time schedules

Step 1: Selection and enabling of time schedules

Press OPTION > 2 sec. SEL and current time displayed Press UP: SEL and PRO displayed, clock symbol blinks Press OPTION: PRO1 shows with 1 blinking. UP/DOWN select time schedule group Press OPTION OFF/ ON blinks, UP/DOWN to change, OPTION to save	SEL PRO 	Pro1-Pro4 OFF/ON
---	---	---------------------

Step 2: Select weekdays

This time schedule will be active during the selected weekdays Press UP/DOWN to step through available options: d1-7, d1-6, d1-5, d6-7, day1, day2, day3, day4, day5, day6, day7 Day 1 stands for Monday, day 2 for Tuesday and so forth Press OPTION to save day selection	Pro1 d1-7
---	--------------

Step 3: Selected action of first switching event

One bar on the right side indicates the first switching event Press UP/DOWN to select action for first switching event: No = switching event not active OFF = switches unit off, Reset (UP17) active if switched to ON manually. Eco = sets operation mode to On and Economy (Not occupied), reset (UP17) active if set to comfort manually On = sets operation mode to On and Comfort (Occupied) Uni = University mode, Reset (UP17) not active if manually activated Press OPTION to select switching time of first event	Pro1 no 
---	---

Step 4: Selected time of first switching event

Press UP/DOWN to select switching time: Select switching time 00:00 to 23:45 in 15-minute steps Press OPTION to complete and select action of second switching event	Pro1 08:00 
--	--

Step 5: Select actions and time of switching event 2 - 4

Repeat Step 3 and Step 4 for the remaining switching events. If a switching event is not needed, set it to "no" The bars on the right side indicate number of switching event After completing the 4 th switching event, the process returns to the selection of the time schedule on step 1.	Pro1 08:00 
---	--

- ➔ UNI: University mode: This switching mode is used for rooms such as lecture rooms and auditoriums that might be occupied during a certain time. During this time the reset is not active. The unit will not start itself when UNI mode is active. It still needs to be manually activated. This is to avoid unnecessary heating or cooling of such rooms while they are not occupied.
- ➔ A blinking clock indicates that the time needs to be set. Time programs will not operate if the time is not defined. See chapter operation, advanced settings for instructions on how to set the time.
- ➔ Access to time schedules may be disabled with UP-04

Operation with OPR-1

The deluxe version may be alternatively operated with an infrared remote controller.

1. Mode indication, Auto, Dry, Cool, Fan, Heat
2. 2-digit display of setpoint
3. Fan indication
4. 4-digit display of current time or delayed switching time
5. Economy button: Toggles Economy/Comfort mode
6. Mode button, changes operation modes
7. UP/DOWN Button: Set point adjustment buttons
8. FAN Button: Changes fan speed, low – medium – high or Auto
9. Boost button, activates full output for 5 Minutes
10. Time related buttons: Timer, Hour, Minute
11. POWER Button: Operation mode ON – OFF

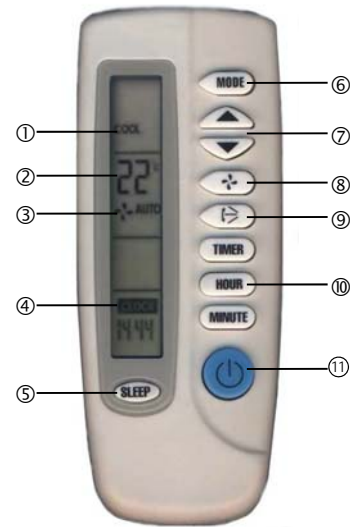

Switching ON

The unit is switched on by pressing the POWER button. It will start up in comfort mode.

Changing between COMFORT and ECONOMY

Pressing the SLEEP button toggles between ECONOMY and COMFORT modes.

Switching OFF

Pressing the POWER while the unit is on, will switch the unit off. The current time will be displayed in the LCD of OPR-1.

Changing of set points

Only the set points for the temperature loop may be changed. Set point range is 15 to 30 °C.

Changing of fan speeds

Repeatedly pressing the fan speed button steps through low, medium, high and automatic fan speeds. Automatic fan speed will not be activated in FAN ONLY mode.

Boost

Pressing the boost button activates a 5 minute boost. The output will be fully opened for the period of 5 minutes independent of demand. This may be used to change stale air during a meeting break or when entering the room.

Clock settings

The remote controller contains a daytime clock. In order to set the clock, press HOUR and MINUTE button together until the clock starts blinking. Then set the correct time with the HOUR and MINUTE buttons. Confirm by pressing the TIMER button. The clock of the OPR will set the clock of the controller.

Delayed switching

The unit may be delayed switched on or off using the timer button. Pressing the timer button once will display Timer ON if currently in OFF mode or TIMER OFF if currently in ON mode. Set the time when the unit is supposed to switch on or off using the HOUR and MINUTE buttons.

Mode changes

Repeatedly pressing the mode button may activate the following operation modes: HEAT, COOL and FAN ONLY. The mode change may be disabled using the UP parameters.

Note:

The remote controller is currently only available in °C mode.

Setting of user parameters

The TLC3-FCR-2 is an *intelligent* controller and can be adapted to fit perfectly into your fan coil application. The control operation is defined by parameters. The parameters are set during operation by using the standard operation terminal.

The parameters are password protected. There are two levels of parameters: User operation parameters for access control settings and Expert parameters for control functions and unit setup. The passwords for user levels and expert levels are different. Only control experts should be given the control parameter password.

The parameters can be changed as follows:

1. Press UP and DOWN button simultaneously for three seconds. The display will indicate the firmware version in the upper large digits and the revision in the lower small digits. Pressing any key will show: CODE.
2. Select a password using UP or DOWN buttons. Select 009 in order to get access to the user parameters, 241 for controls parameters.
Press OPTION after selecting the correct password.
3. Once logged in, the parameter is displayed immediately
4. Select the parameters with the UP/DOWN keys. Change a parameter by pressing the OPTION key. The MIN and MAX symbols show up and indicate that the parameter may be modified now. Use UP and DOWN key to adjust the value.
5. After you are done, press OPTION or POWER in order to return to the parameter selection level.
6. Press the POWER key again so as to leave the menu. The unit will return to normal operation if no key is pressed for more than 5 minutes.

User Parameters

Parameter	Description	Setting Range	Factory Setting
UP 00	Enable change of operation modes	ON, OFF	ON (Enabled)
UP 01	Enable change of set points	ON, OFF	ON (Enabled)
UP 02	Enable manual control of fan speeds	ON, OFF	ON (Enabled)
UP 03	Enable change of heating/cooling mode	ON, OFF	W00: ON (Enabled) W01: OFF (Disabled)
UP 04	Enable access to Time programs	ON, OFF	ON (Enabled)
UP 05	State after power failure: 0 = Switched OFF, 1 = Switched ON, 2 = state before power failure	0, 1, 2	2
UP 06	Enable Economy (unoccupied) Mode. Shift the set point to a lower temperature in winter or higher temperature in summer in order to save energy. Economy mode may be activated through the POWER button, or with the external input (typically for key card switches in hotel rooms or motion detectors for meeting rooms.)	ON, OFF	ON (Economy)
UP 07	Celsius or Fahrenheit, Select ON for Fahrenheit, OFF for Celsius	ON, OFF	OFF (Celsius)
UP 08	Calibration value of temperature sensor . This value is calibrated at manufacturing of the thermostat. If required it is possible to shift the temperature -10° to $+10^{\circ}$ in 0.1° K steps.	-10...10	0
UP 09	Enable Frost Protection. Activates the output independent of operation mode when the control temperature drops below 5°C or 41°F . The controller returns to normal operation when the temperature increases above 10°C or 50°F .	ON, OFF	W00 = ON (Frost Protection) W01 = OFF (No Frost Protection)
UP 10	Select contents of Large LCD display in standard mode: 00 = OFF 01 = Setpoint 02 = Temperature Sensor 03 = Output Fan Speed 04 = Clock	0...4	02 Temperature
UP 11	Select contents of small LCD display in standard mode (use table of UP 10)	0...4	04 Deluxe: show clock 01 Standard: show setpoint
UP 12	Contents of vertical bar in standard mode OFF = Fan Speed ON = Control output	ON, OFF	OFF (FAN)
UP 13 Deluxe only	Clock display type: OFF = Show 24hour clock ON = Show 12hour clock (AM, PM)	ON, OFF	OFF (24h)
UP 14 Deluxe only	Reset: applies when the unit is manually switched on, while in scheduled off mode. The unit will switch automatically back to the scheduled mode when the reset time expires. 0 = Reset of override mode is not active. 1...255 = delay in minutes to switch off device	0...255	60 (Min)

Control configuration

Identifying the firmware version

The parameters and functionality of controller depend on its firmware revision. It is therefore important to use a matching product version and parameter set. The firmware version is shown on the large LCD digits when pressing UP and DOWN buttons for more than 3 seconds simultaneously.

Control Parameters (Access code: 241)

Warning! Only experts should change these settings! See user parameters for login procedure.

Parameter	Description	Range	Standard
FC 00	Minimum setpoint limit in Heating mode	-40...60°C (160°F)	16°C (61°F)
FC 01	Maximum setpoint limit in Heating mode	-40...60°C (160°F)	24°C (75°F)
FC 02	Minimum setpoint limit in Cooling mode	-40...60°C (160°F)	18°C (64°F)
FC 03	Maximum setpoint limit in Cooling mode	-40...60°C (160°F)	30°C (86°F)

Controls configuration

FC 04	Economy (unoccupied) Mode temperature shift: The comfort (occupied) setpoint is shifted by the value set with parameter. If heating is active the comfort setpoint will be decreased, if cooling is active, the setpoint will be increased. (Enable with UP06.)	0...10.0°C (20.0°F)	5.0°C (10°F)
FC 05	Switching Span Heating, Setting this value to 0 disables the auto fan speed function in heating mode	0...10.0°C (20.0°F)	1.5°C (3°F)
FC 06	Switching Span Cooling Setting this value to 0 disables the auto fan speed function in cooling mode	0...10.0°C (20.0°F)	1.0°C (2°F)
FC 07	Switching Hysteresis is the difference between switching on and switching off. A small hysteresis will increase the number of switching cycles and thus the wear on fan and relays contacts.	0...10.0°C (20.0°F)	0.5°C (1°F)
FC 08	Mold Protection: In mold protection, the fan keeps running independent of temperature as long as the unit is switched on.	ON, OFF	OFF
FC 09	Switching delay min running time of fan speed	0...255s	10s
FC 10	Switching delay min stopping time of fan speed	0...255s	10s
FC 11	Control option: 0 = Cooling only 1 = Heating only 2 = 2-pipe system 3 = 4-pipe system	0...3	Default = 3 W01 = 0 W02 = 1 W03 = 2 W04 = 3
FC 12	Dead Zone Span: The Dead Zone Span lies between the heating and the cooling setpoint. The output is off while the temperature is within the dead zone span. A negative dead zone is not possible.	0...10.0°C (20.0°F)	1.0°C (2°F)
FC 13	Heat/Cool Changeover Delay (if set to FC11 = 3): A demand to switch between heating and cooling must persist for the length of time set with this parameter before the controller switches. Prevents activation of a sequence during a short-term change in temperature in order to protect equipment (with control overshoot for example)	0...255 min	5 min

Control Configuration for PWM – 3-point floating mode

FC 14	P – band heating X_{PH}	0-10.0°C (20.0°F)	2.0°C (4.0°F)
FC 15	P – band cooling X_{PC}	0-10.0°C (20.0°F)	2.0°C (4.0°F)

→ **Proportional control (P-band)**

The proportional control function calculates the output based on the difference between setpoint and measured value. The proportional band (P-band) defines the difference between setpoint and measured value which will result in a 100% output. Setting the proportional band to 0 disables proportional control.

Output configuration

FC 16	Output setting, Binary, PWM or 3-point: 0 = Binary or PWM (DO4 Heating, DO5 Cooling) 1 = 3-point binary output (DO4 open, DO5 close) 2 = 3-point floating output (DO4 open, DO5 close)	0...2	0 Binary / PWM
FC 17	Running Time in 3-point mode	0...255 s	90 s
FC 18	PWM cycle time heating, 0 disables PWM mode	0...100 min	0
FC 19	PWM cycle time cooling, 0 disables PWM mode	0...100 min	0

→ **3-point floating:**

For floating point outputs the running time of the actuator used needs to be specified with FC17. Running time is defined as the time required for the actuator to run from fully open to fully closed and vice versa. Actuators with a fixed running time are recommended. Once fully open or fully closed the running time for the actuator is extended for a full run-time cycle. This will allow the actuator position to be synchronized in case it has been moved during off time or an actuator with variable running time was used.

→ **Pulse With Modulation (PWM)**

In PWM mode the digital output will be switched on/off once per cycle. The on and off times are calculated according to the control sequence.

Notes: